

Executive department: SVA	Responsible department: SVA	Document type: Technical Documentation	State of confidentiality: External		
Created/changed (current index): 2024-05-02, W. Pickart		Operating and Installation Manual	Document state: Approved		
Checked (current index): 2024-05-02, I. Fuhrmann					
Approved (current index): 2024-05-03, Dr. D. Mahl		File name: FNC_Rail_HT_Manual_en02.docx	Revision: 02	Language: EN	Page: 1



Batteries rail | power FNC-HT (High Temperature)

Operating and Installation Manual



Version overview

Revision	Date	Status	Name	Chapter	Reason for Change
00	2022-02-22	Created	W. Pickart	-	first issue
	2022-02-28	Checked	T. Schreckenberger		
	2022-02-28	Approved	Dr. D. Mahl		
01	2022-09-26	Created	W. Pickart	8.3	Chapter refined
	2022-09-30	Checked	T. Schreckenberger		
	2022-10-04	Approved	Dr. D. Mahl		
02	2024-05-02	Changed	W. Pickart	<ul style="list-style-type: none"> • 5.3 • 9.1.7.1 13.1 • 9.2.1 9.2.3 • 9.2.1.2 	<ul style="list-style-type: none"> • Added chapter on environmental conditions • Introduction of the new degassing tube (Hoppecke Mat.-No. 4143180110) • Wording changed from washer to spring washer and screw exchange removed • Sequence of action instruction changed
	2024-05-02	Checked	I. Fuhrmann		
	2024-05-03	Approved	Dr. D. Mahl		

Foreword

Dear Customer,

Thank you very much for having decided in favour of a product bearing our brand name.

Please read this documentation carefully before working on the batteries or their components. It contains important information on safe and proper unpacking, storage, installation, commissioning and on operation and maintenance of rail | power FNC-HT batteries.

Amendments to this documentation are subject to change without prior notice. Our products undergo continuous advanced development. As a result, there may be deviations between the illustrations given in this documentation and the purchased product. This installation manual is not covered by any change service.

Keep this documentation in such a manner that it is available immediately to all those who need to carry out work in connection with the battery system or its components.

HOPPECKE Batterie Systeme GmbH
Business Unit Special Power
Postfach 11 80, D-59914 Brilon
Bontkirchener Str.1, D-59929 Brilon

Telefon: +49 (0) 29 63 61 1412
Fax: +49 (0) 29 63 61 1452

Internet: www.HOPPECKE.com
Email: hbs@hoppecke.com



Service hotline Germany:
0800 246 77 32

International service hotline:
+49 (0) 180 5 22 9999

Copyright HOPPECKE Batterie Systeme GmbH

All rights reserved including those of patent and utility model applications.

Disclosure of as well as copying this documentation and using or revealing its contents are not permissible unless this has been expressly approved in writing by HOPPECKE Batterie Systeme GmbH. Infringements will lead to liability for damages.

Table of Contents

1.	USING THIS MANUAL	7
1.1.	Target group of this document	7
1.2.	Icons and signal words	7
1.3.	Notation of nominal data	8
1.4.	Graphic symbols / pictograms on the battery system	9
1.5.	Nameplate information on the product	10
1.6.	Definitions of terms	10
1.7.	Other applicable documents	10
2.	SAFETY INSTRUCTIONS	11
2.1.	Potential hazards	11
2.1.1.	Explosive gas mixture	11
2.1.2.	Electrical voltage	12
2.1.3.	Electrolyte	13
2.1.4.	Toxic substances	14
2.1.5.	Fire	14
2.1.6.	Improper transport	15
2.1.7.	Notes on disassembly	15
2.2.	Personal protective equipment	16
2.3.	Markings on the product	16
3.	USE OF THE PRODUCT	17
3.1.	Intended use	17
3.2.	Unintended use	17
4.	DIRECTIVES, LEGISLATION AND STANDARDS	18
5.	FUNCTION AND STRUCTURE	19
5.1.	Battery	19
5.2.	rail power FNC-HT cell	19
5.3.	Environmental conditions for FNC rail cells	21
5.4.	Low pressure water refilling system	21
5.5.	Charging procedures for rail power FNC-HT cells	23
5.5.1.	Charging with constant current (I)	23
5.5.2.	Single-stage charging with constant current, constant voltage (IU)	24
5.5.3.	Two-stage charging with constant current, constant voltage (IU0U)	25
5.6.	Temperature compensation	26
6.	INSTRUCTIONS FOR TRANSPORT	30

6.1.	Surface transport (Road/Rail) according to ADR/RID	30
6.2.	Transport by sea according to the IMDG Code	30
6.3.	Air freight	31
7.	STORAGE INSTRUCTIONS	31
7.1.	General instructions	31
7.2.	Storage period	32
7.3.	Storage with built-in battery	33
8.	COMMISSIONING/INSTALLATION	34
8.1.	Checking the delivery	35
8.2.	Measures prior to initial commissioning	35
8.2.1.	Preparation	35
8.2.1.1.	Replacing the battery cell transport plugs	36
8.2.1.2.	Recommendation of additional measures	36
8.2.1.3.	Preparation of batteries with unfilled cells	37
8.2.2.	Commissioning charge	39
8.2.2.1.	Preparation	40
8.2.2.2.	Execution	41
8.2.2.3.	Follow-up work	42
8.3.	Installation and connection	43
8.4.	Recommissioning after test or parking operation	45
9.	MAINTENANCE	46
9.1.	Preventive maintenance	46
9.1.1.	Perform visual inspection	47
9.1.2.	Checking the electrolyte level	48
9.1.3.	Measuring the charging voltage	50
9.1.4.	Fill up the electrolyte level with distilled water	52
9.1.4.1.	Fill up distilled water manually	53
9.1.4.2.	Refill distilled water with the central water refilling system	53
9.1.4.3.	Refill distilled water with the water refill cart for single cells	54
9.1.5.	Cleaning the battery	55
9.1.6.	Testing the insulation resistance	56
9.1.7.	Reconditioning	58
9.1.7.1.	Preparation	60
9.1.7.2.	Execution	62
9.1.7.3.	Follow-up work	65
9.2.	Corrective maintenance	66
9.2.1.	Change of rail power FNC-HT cells	66
9.2.1.1.	Prepare the rail power FNC-HT cell(s) to be replaced	67
9.2.1.2.	Replace one or more rail power FNC-HT cell(s)	69
9.2.2.	Exchange of the temperature sensor	72
9.2.3.	Exchanging a cell connector	74
10.	TROUBLESHOOTING	76
10.1.	Insufficient capacity	76

10.2.	Insufficient insulation resistance	76
10.3.	No battery voltage can be measured	77
10.4.	Malfunction of the water refilling system	78
10.5.	Malfunction of the temperature sensor	79
11.	DISASSEMBLY / ASSEMBLY OF RAIL POWER FNC-HT CELLS AND ACCESSORIES	82
11.1.	Disassembly of rail power FNC-HT cells and accessories	82
11.2.	Assembly of new rail power FNC-HT cells and accessories	86
12.	DISPOSAL	91
13.	APPENDIX	92
13.1.	Additional tools	92
13.2.	Commissioning protocol for HOPPECKE rail power FNC-HT batteries	94
13.3.	Maintenance protocol for HOPPECKE rail power FNC-HT batteries	96
13.3.1.	Half-yearly maintenance interval	97
13.3.1.1.	Maintenance - Visual inspection of the battery system	97
13.3.1.2.	Maintenance - Check electrolyte level	98
13.3.2.	Yearly maintenance interval	99
13.3.2.1.	Maintenance - Measurement of the charging voltage	99
13.3.2.2.	Maintenance - Fill up electrolyte level	100
13.3.2.3.	Maintenance - Cleaning	101
13.3.2.4.	Maintenance - Measurement of the insulation resistance	102
13.3.3.	Maintenance Interval every 5 years	103
13.3.3.1.	Maintenance - Reconditioning	103
13.3.3.2.	Maintenance - Measurement of voltage of single rail power FNC-HT cells	104

1. Using this manual

This operating and installation manual is intended to assist with the optimal operation of the HOPPECKE nickel-cadmium batteries used, as well as their installation and maintenance. This is the only way in which a maximum service life can be achieved.

Please contact your local authorised dealer if:

- You have any queries on this documentation
- There are local regulations or provisions that are not covered by this documentation or are contrary to its contents

1.1. Target group of this document

All work on the rail | power FNC-HT cells may only be carried out by trained, fully qualified, authorised personnel (ideally by qualified electricians):

- Personnel authorised by the safety officer of the train manufacturer
- Personnel authorised by the safety officer of the train operator
- Personnel authorised by HOPPECKE
- HOPPECKE specialist personnel

Untrained personnel may not carry out any work on the rail | power FNC-HT cells.

1.2. Icons and signal words

The following icons and signal words are used in this operating and installation manual:



DANGER!

Denotes an immediate hazard with a high level of risk that could lead to death or severe physical injury if it is not prevented.



WARNING!

Denotes a potential hazard with a medium level of risk that could lead to death or severe physical injury if it is not prevented.



CAUTION!

Denotes a hazard with a low level of risk that could lead to minor or medium degree of physical injury if it is not prevented.



Note

Denotes important instructions to make best use of the product.

1.3. Notation of nominal data

Nominal battery data is used in accordance with the following notation in this operation and installation manual:

Notation	Meaning	Value
U_n	Nominal voltage	1.2 V multiplied by the number of cells connected in series
C_n	Nominal capacity	C_5 (according to IEC EN 60623) available capacity at discharge at I_5 (see nameplate) down to 1.0 V for each cell connected in series at nominal temperature
I_n	Nominal current	I_5 (see nameplate) = $C_n/5h$
T_n	Nominal temperature	20 °C
d	Electrolyte density	1.15 kg/l
D	Torque of terminal screws	M8: 20 Nm ± 1 Nm M10: 25 Nm ± 1 Nm
U_0	Open-circuit voltage	1.3 V ... 1.35 V, fully charged

1.4. Graphic symbols / pictograms on the battery system

Following graphic symbols are used in this operating and installation manual:



EN ISO 7010 - W012
Warning of electrical voltage



EN ISO 7010 - W026
Warning about danger from batteries



EN ISO 7010 - W023
Warning of corrosive substances



EN ISO 7010 - W002
Warning against explosive substances



EN ISO 7010 - P003
Fire, open light and smoking prohibited



EN ISO 7010 - M002
Follow instructions for use



EN ISO 7010 - M004
Use eye protection



EN ISO 7010 - M009
Use hand protection



EN ISO 7010 - M010
Use protective clothing

1.5. Nameplate information on the product

The nameplate of a battery is attached to the container for the battery cells (container, tray, carrier). On the nameplate you will find the type, the rated voltage, the number of battery cells and the nominal capacity ($C_5 = C_n$) of the battery.

If battery kits are supplied (individual cells with accessories), the nameplate of the battery must be attached by the customer.



Note

The date of manufacture of the rail | power FNC-HT cells is stamped on the tops of each cell. Each cell has a 9-digit cell code on top of the cell lid. The last four digits indicate the production week and year.

Example:

xxxxx2619 => production week 26; production year 2019

1.6. Definitions of terms

The following table explains the terms used in these operating and maintenance instructions:

Abbreviation/Term	Description
Reconditioning	Describes the defined discharge and subsequent charging of the battery with constant current. This can be used to eliminate or reduce operational capacity losses of the battery system.
Float charging	The charge of an accumulator to compensate for its self-discharge with the aim of keeping the accumulator fully charged.
Boost charging	Indicates the charging of an accumulator with increased voltage and a defined current in order to charge the accumulator as quickly as possible.
Electrolyte	rail power FNC-HT batteries are NiCd batteries and contain sodium hydroxide (NaOH) as electrolyte with an addition of lithium hydroxide (LiOH). When handled properly, rail power FNC-HT batteries are safe. Contact with the electrolyte is excluded.
Formats	rail power FNC-HT cells are delivered in different formats: <ul style="list-style-type: none"> • R2 (format 2) • R3 (format 3)

1.7. Other applicable documents

Document name	Description
D00001-300-en<version number>-Water-Refilling.pdf	Instructions for refilling water with an automatic low-pressure water refill system

2. Safety instructions

Observe the following safety instructions when handling the batteries and their components.

2.1. Potential hazards

2.1.1. Explosive gas mixture

Each time the batteries are charged, water is decomposed. This can form a hydrogen-oxygen gas mixture (oxyhydrogen gas), which ignites even at low energy levels.

There is danger through:

- Explosions
- Fires
- Blast waves
- Hot or molten substances flying around

These hazards may be caused by the following ignition sources:

- Short circuits
- Electrostatic charges and discharges
- Smoking
- Open flames / fire, embers and sparks near batteries
- Electrical sparks through switches or fuses
- Hot surfaces with temperatures above 300 °C

There is an immediate, high risk situation which, if not avoided, will result in death or serious injury.

Measures to avert the danger:

- Work with insulated, non-sparking tools.
- Ensure sufficient ventilation of the battery room in accordance with DIN EN IEC 62485-2 so that the potentially explosive gas mixture is removed.
- Avoid electrostatic charging:
 - Do not rub batteries with plastic housings with a dry cloth or a cloth made of synthetic material!
 - Only clean batteries with a cotton cloth moistened with water. Wiping with a cotton cloth moistened with water does not generate any electrical charge.
 - Wipe batteries damp (with water) before removing or tearing off a label.
 - Wear shoes and clothing which, due to their special surface resistance, prevent the formation of electrostatic charges. (see 2.2 Personal protective equipment on page 16)
- Use hand lamps with mains cable without switch (protection class II) or hand lamps with battery (protection class IP54).

2.1.2. Electrical voltage

Metal parts of the batteries are always live. High currents flow in the event of a short circuit.

There is danger from:

- Voltages
- Electric shocks

There is an immediate, high risk situation which, if not avoided, will result in death or serious injury.

Measures to avert the danger:

- Be very careful when working on the batteries.
- Never place tools or other metal objects on a battery.
- Take off watches and jewellery before working on the batteries.
- Do not touch bare battery parts, connectors and terminals.

2.1.3. Electrolyte

rail | power FNC-HT cells are NiCd cells and contain sodium hydroxide (NaOH) as electrolyte with an addition of lithium hydroxide (LiOH).

The following hazards exist:

- When working on open rail | power FNC-HT cells, contact with the electrolyte may occur.
- Electrolyte may escape as a result of damage to the housing of a cell.
- Polarity reversal of the battery or of individual cells can result in overheating and thus electrolyte leakage.
- The electrolyte can cause severe burns.

There is a potentially hazardous medium-risk situation which, if not avoided, could result in death or serious injury.

Measures to avert danger:

- Always wear protective goggles and gloves when working on batteries.
- Clothes contaminated with electrolyte should be washed with water.
- Check correct polarity before making connections.

Take the following first aid measures if contact with electrolyte has occurred:

Electrolyte on the skin or hair

- Dab the electrolyte with a cotton or paper towel, do not rub off.
- Remove contaminated clothing, avoiding contact with unaffected body parts.
- Rinse affected areas under running water for longer periods of time.

Lye in the eye

- Rinse eye gently with eye wash for a few minutes or rinse under running water. Avoid excessive water pressure. If possible, remove any contact lenses and rinse further.
- Seek medical advice immediately.

Lye in the body

- Rinse mouth. DO NOT induce vomiting.
- Seek medical attention or hospitalization immediately.

2.1.4. Toxic substances

Nickel-cadmium batteries contain toxic substances:

- Battery cells contain more than 0.1% cadmium (Cd)

There is a low-risk hazard which, if not avoided, could result in minor or moderate injury.

Measures to avert the danger:

- Avoid contact with toxic substances.
- Wear personal protective equipment ([see 2.2 Personal protective equipment on page 16](#)).

2.1.5. Fire

In the event of fire there is danger from:

- Hot or molten substances
- Short circuits
- Open flames / fire, embers and sparks
- Hot surfaces with temperatures above 300 °C

There is an immediate, high risk situation which, if not avoided, will result in death or serious injury.

Measures to avert the danger:

- Wear personal protective equipment against caustic solution ([see 2.2 Personal protective equipment on page 16](#)), also use breathing protection with self-sufficient breathing air supply for large battery systems. In the event of contact with water, there is a risk of reactions with the electrolyte (caustic solution) and consequently of violent spraying.
- Disconnect the battery electrically.
- Extinguish incipient fires with CO₂.
- When extinguishing electric fires with water in low-voltage systems (up to 1 kV), maintain a spray jet distance of 1 m and a full jet distance of 5 m.
- Extinguish at short intervals. Otherwise there is danger of explosion due to possible static charging on the battery housing.

2.1.6. Improper transport

The batteries may be damaged during improper transport. Falling batteries can cause personal injury.

If the batteries are transported improperly, there is a risk of damage:

- Suspended loads
- Dropping batteries or parts of batteries
- Leaking electrolyte

There is an immediate, high risk situation which, if not avoided, will result in death or serious injury.

Measures to avert the danger:

- Use safety shoes and goggles.
- Do not tilt batteries.
- Always lift the batteries by the handles or lifting points provided for lifting devices and never carry them by the terminals of the battery or cells.
- Only use approved lifting and transport equipment, e.g. lifting gear. Lifting hooks must not cause damage to cells, connectors or connecting cables.
- Always carefully remove batteries to avoid damage.
- Use suitable transport equipment.
- Carefully secure the load during transport to prevent damage to the battery housing.

2.1.7. Notes on disassembly

If the connecting cables have not been disconnected before replacing the batteries, there is a risk of electric shock.

There is an immediate, high risk situation which, if not avoided, will result in death or serious injury.

Measures to avert the danger:

- Before starting to dismantle the batteries to be replaced, disconnect the supply lines (fuses).

Due to the content of cadmium and sodium hydroxide solution, rail | power FNC-HT batteries must not be disposed of with garbage or deposited in a landfill at the end of their service life. ([see 12 Disposal on page 91](#))

2.2. Personal protective equipment

Always when working on the batteries and their components:

- Wear safety goggles
- Wear protective gloves
- Wear protective clothing, preferably made of cotton, to avoid electrostatic charging of clothing and body
- Wear safety shoes

In the event of an accident, injuries can thus be prevented or at least the consequences of injury mitigated.

The conductivity of textiles and shoes must have the following properties in order to avoid electrostatic charging:

- an insulation resistance $\geq 10^5$ Ohm
- a surface resistance $< 10^8$ Ohm

2.3. Markings on the product

The type plate of a battery is attached to the container for the battery cells (container, tray, carrier). On the type plate you will find the type, nominal voltage, number of battery cells and nominal capacity ($C_5 = C_n$) of the battery.

When battery kits (individual cells with accessories) are supplied, the type plate of the battery must be attached by the customer.

3. Use of the product

3.1. Intended use

The rail | power FNC-HT cells of the battery are used to store and release electrical energy in rail vehicles.

Use only in rail vehicles for:

- Buffering and supply of the low-voltage vehicle electrical system
- Provision of energy in emergencies
- Provision of energy for the maintenance and start-up of vehicles
- Start of the vehicle drive motors

Intended use includes the following requirements:

- Operation of the batteries only in perfect condition
- No deactivation or dismantling of safety devices
- Compliance with all instructions in this operating and maintenance manual

3.2. Unintended use



DANGER!

The improper use of the batteries can lead to personal injury and damage to property. HOPPECKE Batterie Systeme GmbH assumes no responsibility and no liability for personal injury or damage to property resulting directly or indirectly from handling the batteries if they are not used as intended. The risks associated with improper use are borne solely by the operator.

Any other use than described under "Intended use" is not intended and therefore not permitted.

The improper use of the product includes in particular:

- Operation in potentially explosive atmospheres
- Operation in safety-relevant applications, unless these applications are expressly specified or permitted in the product documentation.
- Operation without permanent/insufficient fastening
- Operation outside the technical data
- Operation or storage outside the specified environmental conditions
- The electrical connection does not correspond to the documentation supplied with the battery.
- Operation with unauthorized changes or modifications to the product

4. Directives, legislation and standards

Observe the latest edition of the following rules and regulations:

- Accident prevention regulations, especially DGUV Regulation 1: Accident prevention regulation; Principles of prevention
- DIN EN ISO 20345 ("Personal safety gear – Safety boots")
- DIN VDE 0105 ("Operation of electrical equipment"), in particular, governs the requirements for quality and qualification for working on electrical equipment (DIN VDE 0105-100) and on electrical equipment for railways (DIN VDE 0105-103).
- DIN VDE 100/IEC 60364 ("Erection of low-voltage installations")
- DIN EN 50110/VDE 0105 ("Operation of electrical installations")
- DIN EN 50155 ("Railway applications - Electronic equipment used on rolling stock")
- DIN EN IEC 62485-2: ("Safety requirements for secondary batteries and battery installations") especially applicable for the calculation of the necessary ventilation of battery rooms (in DIN EN IEC 62485-2).
- DIN EN IEC 62485-3: ("Safety requirements for secondary batteries and battery installations") Part 3: Traction batteries for electric vehicles
- DIN EN 50547 Railway applications - Batteries for auxiliary power supply systems
- DIN EN 60077 ("Railway Applications - Electric equipment for rolling stock")
- DIN EN 60623/IEC 60623 ("Secondary cells and batteries containing alkaline or other non-acid electrolytes. Vented nickel-cadmium prismatic rechargeable single cells"), applicable primarily to the testing of cells (type test, series production test and field test). Based on mutual agreement, the tests may also be conducted in accordance with the French standard for rolling stock, NF F 64-018.
- DIN EN 60993/IEC 60993 ("Electrolyte for vented nickel-cadmium cells")
- DIN 43530-4 ("Water and refilling water for lead acid batteries and alkaline batteries")
- DIN VDE 0119-206-4: State of railway vehicles - Electric and traction systems, train electric equipment - Part 206-4: Batteries
- ADR/RID: European Treaty on the international transport of hazardous goods by road / Ordinance on the international transport of hazardous goods by rail
- IATA-DGR: Dangerous goods regulations - international air transport association. German: Gefahrgut-Bestimmungen - Internationale Flug-Transport-Vereinigung
- IMDG Code: International Maritime Code for Dangerous Goods, German: Gefahrgutkennzeichnung für gefährliche Güter im Seeschiffsverkehr
- Ordinance on the supervision of waste and residual materials (German Federal Law Gazette, 1996)

In addition, observe and follow all applicable territorial, corporate and project-specific regulations.

5. Function and structure

5.1. Battery

Batteries are interconnected from rail | power FNC-HT cells and used in rail vehicles.

Here they fulfil one or more of the following functions:

- - Buffering and supply of the low-voltage vehicle electrical system
- - Provision of energy in emergencies
- - Provision of energy for the maintenance and start-up of vehicles
- - Start of the vehicle drive motors

5.2. rail | power FNC-HT cell

rail | power FNC-HT cells are nickel-cadmium cells manufactured using fiber structure technology using an extremely porous, three-dimensional nickel-metallised polypropylene fleece.

Decisive features are:

- Best volume/weight ratio due to 90% volume filling of the fiber electrodes with active material
- High to very high currents possible during discharge and charging
- No carbonates are formed in the electrolyte
- Long service life and many charging cycles even under extreme temperature conditions
- Resists highest shock and vibration demands
- Cell vessels optionally made of:
 - Polypropylene (PP)
 - Flame retardant polypropylene (PP-V0)
 - Polyethersulfone (PES)
- Wide variety of designs from high and extremely flat to low with large footprint

The following drawing shows the internal structure of a rail | power FNC-HT cell:

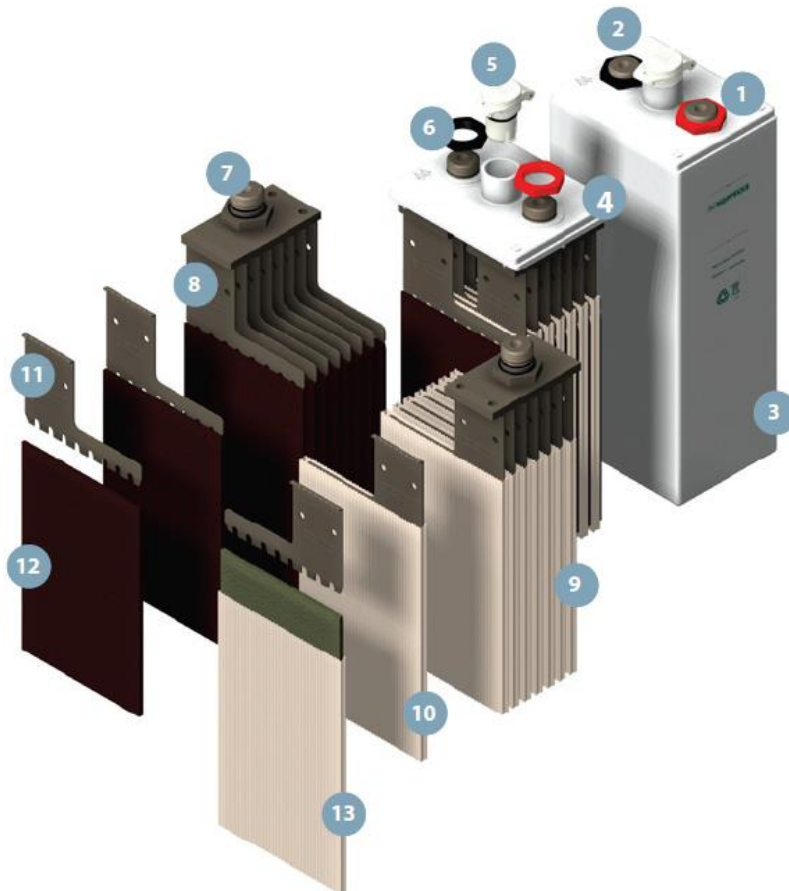

- 1 - Positive terminal
- 2 - Negative terminal
- 3 - Cell container
- 4 - Cell lid
- 5 - Vent plug
- 6 - Terminal nut
- 7 - Cell terminal

- 8 - Negative electrode stack
- 9 - Positive electrode stack
- 10 - Positive fiber structure electrode
- 11 - Tab
- 12 - Negative fiber structure electrode
- 13 - Separator



Note

The electrolyte used in the cells of the rail | power FNC-HT batteries is sodium hydroxide (NaOH) with an addition of lithium hydroxide (LiOH). The standard alkali density is 1.15 ± 0.02 kg/litre.

In contrast to the lead-acid battery, the alkaline density is not a measure of the state of charge.

5.3. Environmental conditions for FNC rail cells

Environmental conditions according to EN 50125-1	Description
Temperature class T1 & T3 with electrolyte density 1.19 kg/l	<ul style="list-style-type: none"> • ambient temperatures -25°C ... +45°C, • inside temperatures -25°C ... +55°C
Temperature class T2 & TX with electrolyte density 1.236 kg/l	<ul style="list-style-type: none"> • ambient temperatures -40°C ... +50°C, • inside temperatures -40°C ... +60°C
Altitude class AX	More than 1400 m

5.4. Low pressure water refilling system

A water refill system can be an optional part of your battery. The low pressure water refilling system allows the electrolyte levels of the rail | power FNC-HT cells to be filled with distilled water.

It consists of water refill plugs in the rail | power FNC-HT cells, hoses and a backfire protection unit.

The following picture shows a water refill plug:



The following picture shows a backfire protection unit (example):

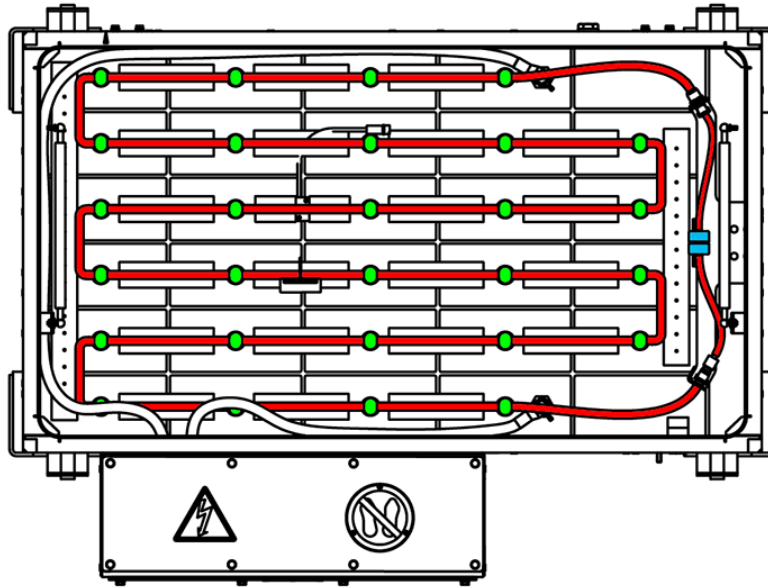

The following picture shows an example of a battery with a coloured water refill system (tubing = red; backfire protection = blue, water refill plugs = green):

**Note**

For water refilling with a water refill system, refer to the separate document:
D00001-300-en<version number>-Water-Refilling.pdf

**Note**

The hosing of the water refill system must follow the potential of the electrical wiring of the battery in accordance with EN 62485-3 in order to reduce the occurrence of leakage currents. See also the project-specific technical drawings of the water refill system. This must be observed during all work on the water refill system.

5.5. Charging procedures for rail | power FNC-HT cells

5.5.1. Charging with constant current (I)

With this charging method, the cell is charged with the constant current $I_5 = C_n/5h$. The charging voltage is not limited. However, there is a time limit so that a defined capacity is charged into the cell.

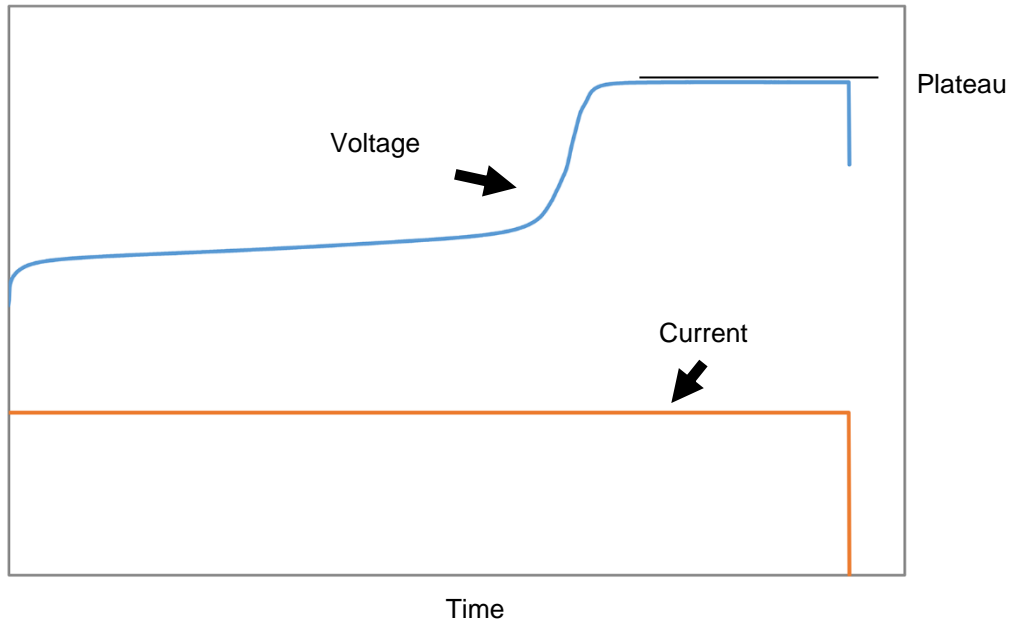

At the end of the charging process, relatively high cell voltages occur (up to 1.9V / cell). In this phase (also called "plateau" or gassing phase) the charging current decomposes water into hydrogen and oxygen. This results in high water consumption.

The IEC60623 standard describes this charging procedure to prepare the cells for subsequent discharge tests. The current limitation is at rated current and the time is in the range of 7 to 8 hours. With this charging method a fully charged state (100%) can be achieved. At the same time, all cells of a battery connected in series are balanced. This method is therefore used for commissioning charging and reconditioning rail | power FNC-HT cells.

This charging method is not used for the daily operation of the batteries due to the strong gassing and the high water consumption. Furthermore, the resulting high voltage is well above the permissible operating voltage of the on-board electrical system.

5.5.2. Single-stage charging with constant current, constant voltage (IU)

This charging method limits both the current (I) and the voltage (U). At the beginning of charging, the charging current is limited and the charging voltage rises slowly. When a defined voltage is reached, it is kept constant by the charger. The current then drops automatically to a low value.

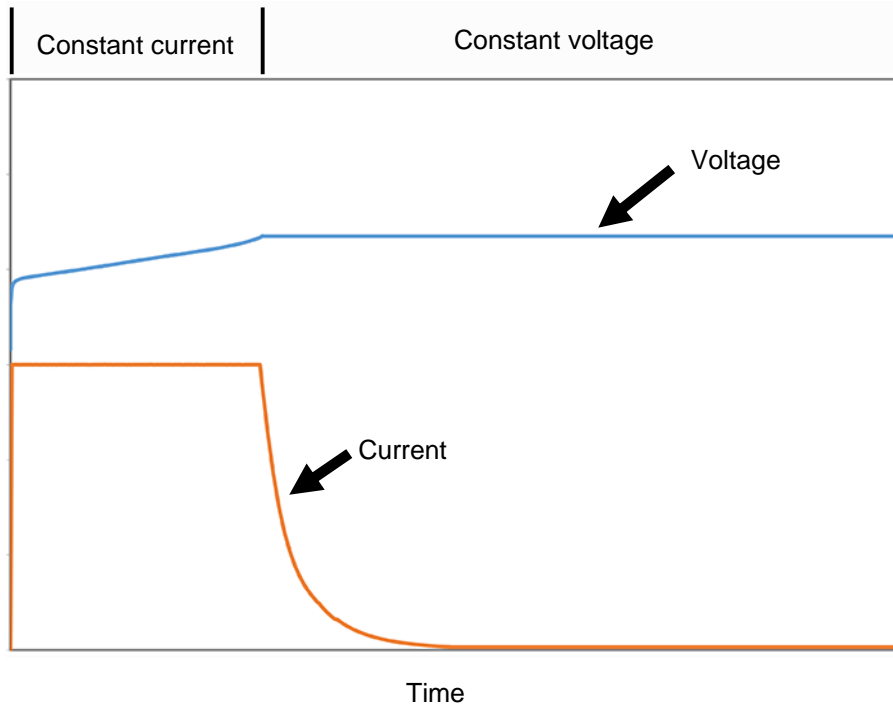

The setting of the charging voltage always represents a compromise between the achievable state of charge and water consumption. The higher the voltage, the higher the state of charge, but the higher the remaining charge current, the higher the water consumption.

In accordance with the limited charging voltage, a reduced state of charge must be assumed for the operation of the battery. Normally a value of 90% of the nominal capacity is assumed (EN 50547). In extreme applications (very high or very low temperatures, cyclic use) this value may also be lower.

5.5.3. Two-stage charging with constant current, constant voltage (IU0U)

The two-stage charging process (IU0U) initially works according to the same principle as the single-stage charging process. First the current is limited, then the voltage is kept constant when a certain value is reached. This first voltage threshold is called the "boost voltage". When the boost voltage is reached, the charge current decays. When a certain charge current is reached (usually $I_{20} = C_n/20h$), the voltage is reduced to a lower value. This voltage value is referred to as the "float voltage".

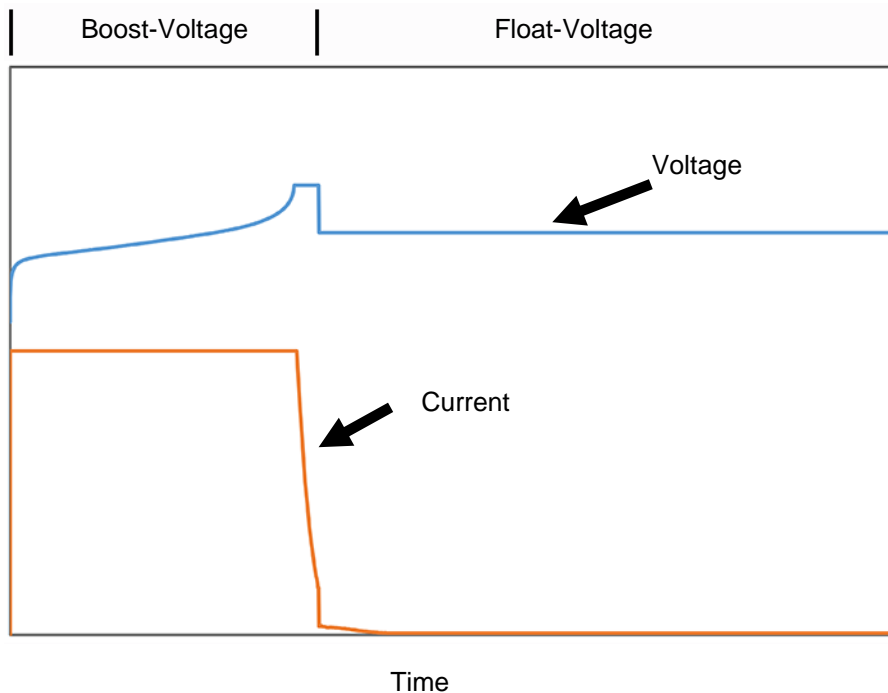

The advantage is that the boost voltage can be selected higher than with a single-stage charge. This extends the constant current phase, resulting in a better state of charge in a shorter time.

After reaching the current threshold (I_{20}), which indicates that the battery has been sufficiently charged, the voltage is switched to the float voltage. This voltage is significantly lower than the voltage at single-stage charging. This keeps water consumption to a minimum while maintaining the state of charge.

If there has been a discharge of the battery, the charging current will increase again. When the switch-over point (I_{20}) is reached, the charging voltage is reset to the boost value to quickly recharge the battery. Then the charging current drops again and the charger switches back to float voltage.

As a result, this charging process eliminates the compromise between water consumption and state of charge of the single-stage charge.

In the case of two-stage charging, a reduction in the state of charge must also be taken into account when the battery is designed. The value is usually in the same range as for single-stage charging.

5.6. Temperature compensation

Like all chemical reactions, the charging and discharging processes in the cell are subject to a temperature effect. In general, chemical reactions are faster when the temperature rises and slower when the temperature falls. For this reason, temperature compensation is used for the charging voltage.

This compensation is used equally for the single-stage (IU) and the two-stage (IU0U) charging process.



Note

Depending on the specific mode of operation of a vehicle and the resulting special load requirements, individual values may differ from those listed below.

Cell-Performance Class acc. EN 60623	Charging Voltage at 20 °C in V per cell connected in series			Temperature compensation in V/°C/Cell; starting from 20 °C
	Single Stage Charging (IU)	Two Stage Charging (IU0U), Float-Charge	Two Stage Charging (IU0U), Boost-Charge	
M	1.52 *)	1.50	1.60	-0.003
H	1.47 *)	1.45	1.55	

*) : Guide values; may vary depending on the project

The following figure shows the charging voltage per cell connected in series as a function of the battery temperature monitored by the charger (IU characteristic).

Temperature compensated charge -3 mV/°C/cell starting from 20 °C for HOPPECKE NiCd batteries 1-stage constant voltage charge with current limitation:

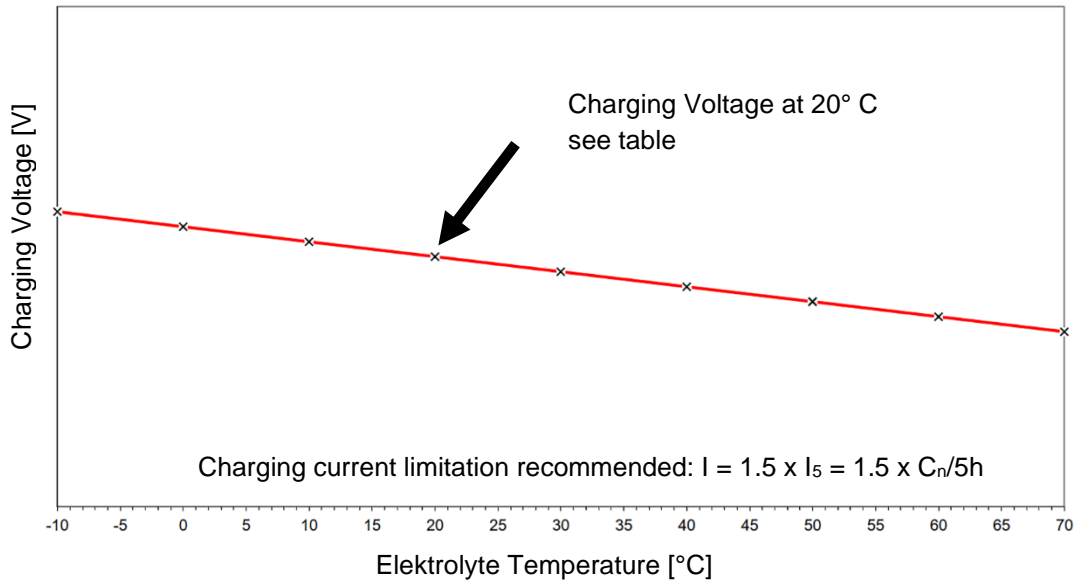

The following figure shows the charging voltage per cell connected in series as a function of the battery temperature monitored by the charger (IU characteristic).

Temperature compensated charge -3 mV/°C/cell starting from 20 °C for HOPPECKE NiCd batteries 2-stage constant voltage charge with current limitation:

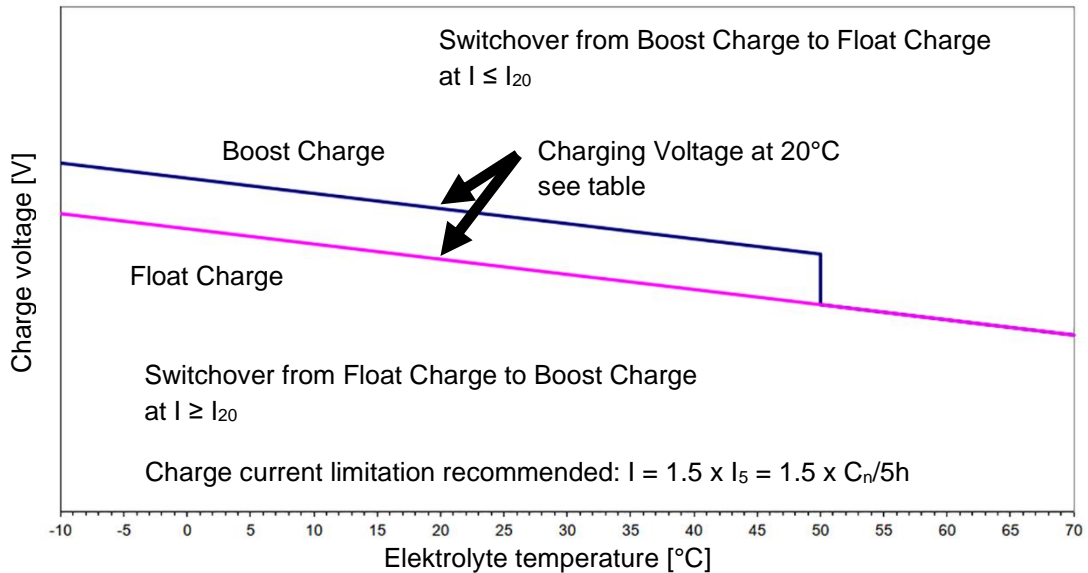

The following conditions apply to the characteristic curve shown:

- Switching from float charge to boost charge:
The current permanently exceeds a value of $I_{20} = C_n/20h$.
- Switching from boost charge to float charge:
The current permanently falls below a value of $I_{20} = C_n/20h$.
- Current limitation $1.5 \times I_5 = 1.5 \times C_n/5h$ (recommended value, deviations to higher or lower currents are possible)
- At a temperature of ≥ 50 °C, a boost charge is not possible. Select the hysteresis in such a way that the switch back to boost charge does not occur until a temperature of ≤ 45 °C is reached.



Note

If the battery temperature \geq is 70 °C, the charging process must be interrupted to prevent damage to the cells. Select a control that does not resume charging until the battery temperature has dropped to \leq 60 °C.



Note

You can assume that the temperature probe of the battery system is defect, if the on-board charger device detects temperatures above +80 °C or below -50 °C.

You have to set the on-board charging device in such a way, that the charging voltage not exceeds the float charge voltage at 45°C.

The on-board charging device should generate a SERVICE message to indicate that you must replace the temperature probe within a few days.

6. Instructions for transport

Observe the regulations for the transport of batteries specified in the following sections.



Note

Observe the safety instructions, see 2 Safety instructions on page 11.

6.1. Surface transport (Road/Rail) according to ADR/RID

Filled batteries having the UN numbers 2795 (batteries/rechargeable batteries, wet, filled with alkalis) are not classified as hazardous goods requiring declaration during transport, if the following requirements are met (according to the ADR special regulation 598, section 3.3):

New batteries, if:	They are secured against sliding, turning over or damage.
	They are provided with carrying facilities, unless, for example, they are stacked on pallets.
	They do not have hazardous traces of caustic solutions or acids on the outside; they are protected against short-circuit.
Used batteries, if:	Their housing is not damaged.
	They are protected against leakage, sliding, turning over or damage, for example, stacked on pallets.
	They do not have hazardous traces of caustic solutions or acids on the outside.
	They are protected against short-circuit.

"Used batteries" are those that are transported for the purpose of recycling after normal use.

If the conditions of special regulation 598 are not complied with, declare and transport new and used batteries as hazardous goods as follows:

UN hazardous goods class	8
UN no. (material number)	2795
Designation and description	BATTERIES, WET, FILLED WITH CAUSTIC SOLUTION
Packaging group	Not assigned to any packaging group
Hazard label	8
ADR tunnel restriction code	E

6.2. Transport by sea according to the IMDG Code

Declare rail | power FNC-HT battery systems for sea freight as follows:

UN hazardous goods class	8
UN no. (material number)	2795
Proper shipping name	BATTERIES, WET, FILLED WITH CAUSTIC SOLUTION
Packaging group	Not assigned to any packaging group
Hazard label	8
EmS	F-A, S-B
Packing instructions	P801

6.3. Air freight

Declare rail | power FNC-HT battery systems for air freight as follows:

UN hazardous goods class	8
UN no. (material number)	2795
Proper shipping name	BATTERIES, WET, FILLED WITH CAUSTIC SOLUTION
Packaging group	Not assigned to any packaging group
Hazard label	8
Packing instruction	870

7. Storage instructions

The service life of the batteries begins with delivery ex works HOPPECKE. Storage periods must be taken into consideration in their entirety for the service life duration.



Note

Observe the safety instructions, [see 2 Safety instructions on page 11](#).

7.1. General instructions

Unpack the battery system as soon as possible after delivery, install it and put it into operation, see chapter [8 Commissioning on page 34](#).

In case this is not possible:

- Store the batteries in a clean, dry and frost-free room.
- Protect the batteries against mechanical damage and contamination.
- Do not expose the batteries to direct sunlight.
- Do not stack the batteries on top of each other.
- Observe and follow project-specific regulations applicable, if any.



Note

The minimum storage temperature is -25 °C.

The ideal storage temperature is +20 °C.

Higher storage temperatures lead to faster self-discharge and premature aging of the battery.

The maximum storage temperature is +60 °C.

During storage, a maximum relative humidity of 90% is permissible.

7.2. Storage period



Note

The storage life of the battery must not exceed three months after manufacture.
If the expected storage life exceeds three months, discharge the battery as described below.
The battery system prepared in this way can be stored for three years.



Note

The date of manufacture of the rail | power FNC-HT cells is stamped on the top of each cell.
Each cell has a 9-digit cell code on top of the cell lid. The last four digits indicate the production week and year.

Example:

xxxxx2619 => production week 26; production year 2019

Steps to prepare the storage of the battery:

Target: The battery is prepared for storage.

1. If the battery was supplied with yellow transport plugs, replace them with water refill plugs or vent plugs.
2. Discharge the battery using a charger/discharger with rated current $I_5 (= C_n / 5h)$.
Discharge until the battery voltage averages 1 V per cell connected in series.

Result: Now the battery is ready for storage.



Note

Recommissioning:

Charge the battery system for recommissioning as described in [8.2.2 Commissioning charge on page 39](#)

7.3. Storage with built-in battery



Note

Ideally, the battery should be stored separately from the vehicle in a clean, dry and frost-free room.

If it is not possible to separate the battery from the vehicle and the vehicle is parked, make sure the battery will not deep discharge.

Disconnect the battery electrically from the electrical system of the vehicle to prevent permanent consumers discharge the battery.

Parking has to be considered as normal operation for maintenance purposes. Carry out the regular maintenance intervals and works, see [9 Maintenance on page 46](#).



Note

When the parking period exceeds 3 months, perform a commissioning before enter revenue service, see [8.2.2 Commissioning charge on page 39](#).

8. Commissioning/Installation



Note

Observe the safety instructions, see [2 Safety instructions on page 11](#).



Note

Batteries can be supplied in various ways:

- Individual cells with connectors and other accessories for installation by the customer.
- Individual carriers installed by the customer in the battery compartment of the vehicle. The cells are already assembled in the carriers.
- Complete battery containers that contain the battery and other electrical components fully assembled. The containers are installed on/in the vehicle by the customer.

Project specific additional information can be included in a separate documentation.

The batteries are usually delivered filled and charged. They can be connected and commissioned within three months of the date of manufacture (stamped on top of the battery cells) without any special preparations.

In the following cases, a commissioning charge must be carried out before installing and commissioning the batteries (see [8.2.2 Commissioning charge on page 39](#)):

- The date of manufacture was more than 3 months ago when the batteries were commissioned.
- Batteries delivered unfilled and uncharged should be put into operation. Carry out the commissioning charge after the batteries have been filled with caustic solution (see [8.2.1.3 Preparation of batteries with unfilled cells on page 37](#)).
- Filled and uncharged batteries should be put into operation.
- The vehicle in which the batteries are used should be put into operation after a long period of standing or transport for the regular route operation, see [8.4 Recommissioning after test or parking operation on page 45](#).

8.1. Checking the delivery

HOPPECKE Batterie Systeme GmbH packages your delivery with the greatest possible care so that it arrives undamaged.

Check the delivery immediately:

- Completeness (comparison with the delivery note)
- Transport damages
- Make a note of:
 - Damage to the outer packaging
 - Visible stains or moisture that would indicate leaking electrolyte.

If the delivery is incomplete or there is damage in transit:

- Write a short defect report on the delivery note before you sign it.
- Ask the carrier for an inspection and note the name of the inspector.
- Write a defect report and send it within 14 days to HOPPECKE Batterie Systeme GmbH and the forwarding agent.

Check the goods for defects:

- Observe the instructions in [2 Safety instructions](#).
- After delivery, unpack the batteries and check them for defects by performing a visual and functional inspection.
- Document any existing defects and send them in text form to Hoppecke Batterie Systeme GmbH within 14 days.



Note

If you notify the freight forwarder too late of defects or incompleteness, this may result in the loss of your claims.

8.2. Measures prior to initial commissioning

8.2.1. Preparation



Note

Accessories such as glass tubes for determining the filling level, equipment for refilling water and chargers are part of the range of accessories offered by HOPPECKE Batterie Systeme GmbH.

8.2.1.1. Replacing the battery cell transport plugs

When the batteries are delivered, the cells can be sealed with one of the following plug types:

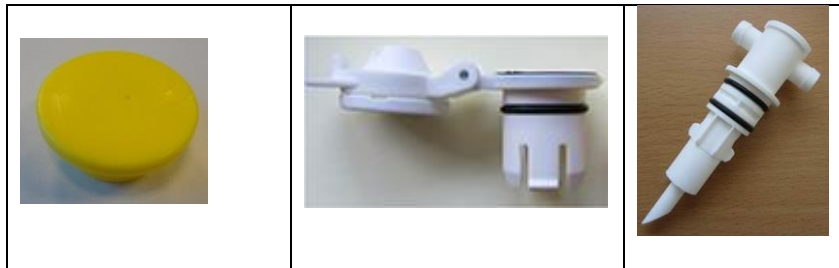

yellow transport plug

white vent plug

water refilling-
plug (low
pressure
System)



Note

The yellow transport plugs prevent the cells from being ventilated and can cause the individual cells to be destroyed when the battery is charged.

If the cells are delivered with yellow transport plugs, replace them with the vent / water refilling plugs supplied separately.



Note

The installation of a water refill system is described in a documentation supplied separately with the battery if required.

8.2.1.2. Recommendation of additional measures

It is recommended to carry out the following additional measures before installing and commissioning each battery:

- Check the cell connectors and their screw connections for tightness.
- Check the insulation resistance of the battery (see [9.1.6 Testing the insulation resistance on page 56](#)).
- Create a commissioning protocol for the battery (see [13.2 Commissioning protocol for HOPPECKE rail | power FNC-HT batteries on page 94](#)).

8.2.1.3. Preparation of batteries with unfilled cells

Target: The unfilled battery is prepared for use in the vehicle.



WARNING!

There is danger through:

- Work on opened rail | power FNC-HT cells. Contact with the electrolyte may occur.
- Damage to the housing. Electrolyte may escape from the affected cell.
- Reverse polarity of the battery or of individual cells. It can cause overheating and thus electrolyte leakage.

There is a potential medium-risk hazard which, if not avoided, could result in death or serious injury.

The electrolyte can cause severe skin burns and eye damage.

Measures to avert the danger:

- Always wear protective goggles and gloves when working on batteries.
- Clothing contaminated with electrolyte should be washed with water.
- Check correct polarity before making connections.

Observe the first aid measures, see [2.1.3 Electrolyte on page 13](#).



Note

Filling with acid destroys the cells of the rail | power FNC-HT batteries. If caustic soda solution is not mixed in accordance with regulations, the battery performance will be impaired.

1. Remove the unfilled battery from storage and set it up in a suitable battery workshop for wet chemistry.
2. Do not remove the yellow transport plugs and allow the battery to acclimatise for 6 hours if the temperature difference between the storage and the battery workshop is more than 10 °C.



Note

An electrolyte change is not necessary during the entire service life of the battery.

3. Remove the yellow transport plugs immediately before filling the battery.
4. Fill each cell of the battery with electrolyte up to approx. 1cm above the minimum mark.
5. Fit the supplied vent plugs (or the water refill plugs and tubing if the water refill system is present).
6. Let the battery rest for 12 hours.
7. Remove the hinged lid plugs or the water refilling system.
8. Mount the gas venting tubes (Hoppecke material number 4143180110) on each cell.
9. Charge the battery with the constant current I_5 for 7.5 hours.

**Note**

The battery must not exceed a temperature of 45 °C during charging.

If a temperature of 45 °C is reached, interrupt charging.

Note the remaining charging time.

Do not continue charging until the cell temperature has dropped to 25 °C.

Complete the charging time of 7.5 hours after the battery has cooled down.

If the battery reaches a temperature of 45 °C again before the 7.5 hour charging time has been completed, interrupt charging again, etc.

10. Let the battery rest for at least 8 hours, preferably overnight.

11. Disconnect the charger/discharger from the battery.

12. Remove the gas venting tubes.

13. Manually fill the electrolyte levels of the cells with electrolyte up to the maximum mark.

Battery cell format	Maximum electrolyte level according to measuring glass tube [mm]
R 2	36 ± 2 (3.5 rings)
R 3	

**Note**

The electrolyte levels of the cells can be checked with the Hoppecke measuring glass tube (Mat-No.: 4144140010), see [9.1.2 Checking the electrolyte level on page 48](#). The measuring glass tube contains a ring scale at which the electrolyte level can be read in rings.

14. Refit the vent plugs or the water refill system.

Result: The battery is now ready for use in the vehicle.

8.2.2. Commissioning charge



Note

- Batteries with unfilled cells must always receive an initial charge after filling. Cells delivered uncharged must also receive a commissioning charge.
- Otherwise the following applies:
 If commissioning is carried out up to 3 months after the date of manufacture, the measures described here are not necessary.
 - The date of manufacture (calendar week and year) of the battery is noted on the nameplate.
 - Furthermore, the date of manufacture of the rail | power FNC-HT cells is stamped on the top of each cell. Each cell has a 9-digit cell code at the top of the cell cover. The last four digits provide information about the production week and year.
 Example:
 xxxxx2619 => production week 26; production year 2019



DANGER!

Explosion hazard due to formation of oxyhydrogen gas!

When the cells are charged, water is decomposed and a hydrogen-oxygen gas mixture (oxyhydrogen gas) is formed, which explodes even at low energy input.

Keep any ignition source away from the battery:

- open flames or fire
- smoking
- glowing sparks
- flying sparks during grinding work
- electrical sparks through switches or fuses
- hot surfaces with temperatures above 300 °C
- electrostatic discharges

Work with insulated, non-sparking tools.

Ground yourself when working directly on the battery.

Ensure sufficient ventilation of the container compartment in accordance with DIN EN IEC 62485-2 so that any explosive gas mixture that may be produced is discharged.



Note

The charge for commissioning is a constant current charge, see [5.5.1 Charging with constant current \(I\)](#) on page 23.

Required tools:

- suitable loading/unloading equipment
- measuring glass tube
- digital Multimeter
- gas venting tube
- contact thermometer

Perform the following activities in the order given here:

Activity	Description
Prepare commissioning charge	8.2.2.1 Preparation on page 40
Execute commissioning charge	8.2.2.2 Execution on page 41
Follow-up work after commissioning charge	8.2.2.3 Follow-up work on page 42

8.2.2.1. Preparation

Target: The cells are prepared for carrying out charging for commissioning.



Note

Carry out measures on the dismantled battery - i.e. mechanically separated from the vehicle - before initial operation.



Note

It is strongly recommended that the charging be carried out for commissioning in an air-conditioned working area at 20 °C (±5 °C).

1. Remove the hinged lid plugs from each rail | power FNC-HT cell or, if present, remove the tubing and the water refill plugs.
2. Remove the insulation profiles.

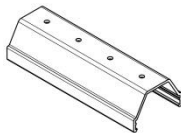

3. Measure the individual cell voltages with a digital multimeter and record the values in a test report.



Note

If the open circuit voltage of a cell is < 1.2 V, contact HOPPECKE Service.

4. Insert a gas venting tube (HOPPECKE material number: 4143180110) on each rail | power FNC-HT cell.

Result: Now the cells are prepared for carrying out the charge for commissioning. Continue with the execution.

8.2.2.2. Execution

Target: The cells are set to the charged state.



Note

Steps 1 and 2 do not apply if the battery was purchased uncharged or if it was discharged beforehand in accordance with [7.2 Storage period on page 32](#).

1. Discharge the battery using a charger/discharger at rated current I_5 until the voltage of the battery has dropped to 1V per cell.
2. Leave the unloaded battery to rest for at least 4 hours.
3. Measure the temperature of the battery, e.g. with a contact thermometer.
The cell to be measured should be installed in the middle of the battery in order to detect the warmest part of the system.
4. Charge the battery at constant current I_5 for 7.5 hours.



Note

If the charger used requires a voltage limit to be entered, set this to 2 V per cell.



Note

The battery must not exceed a temperature of 45 °C during charging.

If a temperature of 45 °C is reached, interrupt charging.

Note the remaining charging time.

Do not continue charging until the cell temperature has dropped to 25 °C.

Complete the charging time of 7.5 hours after the battery has cooled down.

If the battery reaches a temperature of 45 °C again before the 7.5 hour charging time has been completed, interrupt charging again, etc.

5. Let the battery rest for at least 8 hours, preferably overnight.
6. Disconnect the charger/discharger from the battery.

Result: The cells are now charged. Continue with the follow-up work.

8.2.2.3. Follow-up work

Target: After charging, the cells are made ready for operation again.

1. . Remove the gas venting tubes.
2. Measure the electrolyte level in each cell with the measuring glass tube (HOPPECKE material number: 4144140010).
 - Keep the upper opening of the measuring glass tube free and insert it into the cell until it encounters resistance.
 - Close the upper opening of the measuring glass tube with your index finger.
 - Remove it from the cell until the scale is visible.
3. Read off the electrolyte level in the cell using the electrolyte remaining in the measuring glass tube and allow the electrolyte in the measuring glass tube to flow back into the cell.
4. Fill the cells with distilled water to the maximum level.

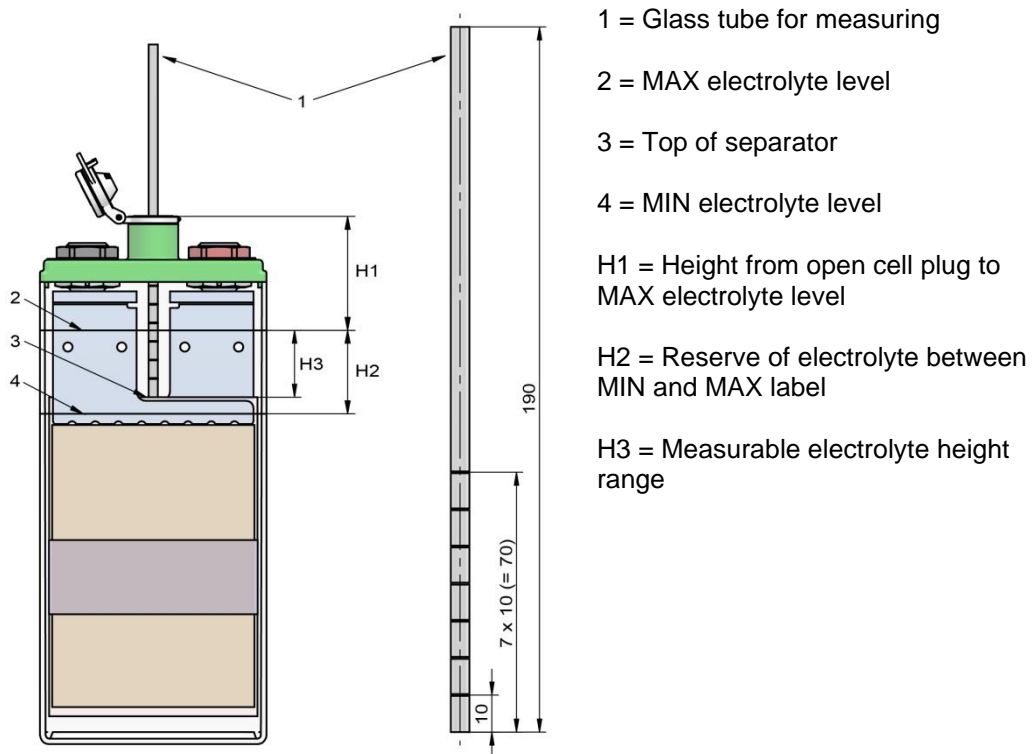

Battery cell format	Maximum electrolyte level according to measuring glass tube [mm]
R 2	36 ± 2 (3.5 rings)
R 3	

5. Insert the vent plugs again or reinsert the water refill plugs and restore the tubing.
6. Thoroughly remove any impurities from the battery with a clean, damp cloth.
7. Measure the individual cell voltages with a digital multimeter and record the values in a test report. If the individual cell voltages deviate more than ± 50 mV from the average of all cell voltages, contact HOPPECKE Service.
8. Remount the insulation profiles.

Result: The cells are now ready for operation again.

8.3. Installation and connection

Target: The battery is connected for use in the vehicle.



DANGER!

Danger of a short circuit between the positive and negative terminals of a battery.

If the positive and negative terminals of a battery are short-circuited, there is a risk of overheating and explosion.

There is an immediate, high-risk hazard which, if not avoided, will result in death or serious injury.

Never short-circuit the positive and negative terminals of a battery.



DANGER!

Danger when connecting a battery to the consumer.

Polarity reversal of batteries may cause overheating and caustic leakage.

There is an immediate, high-risk hazard which, if not avoided, will result in death or serious injury.

Always check the correct polarity before making connections.

Ensure that all loads in the vehicle and the charger are disconnected or switched off.



Note

If the terminals of a battery are damaged, the battery can no longer be used.

Do not damage the terminals of the batteries.



Note

Observe the project-specific electrical circuit diagram.

In case of delivery of so-called battery kits (cells, connectors, terminal screws):

- Install the cells in the battery compartment of the vehicle according to your customer's installation drawing.
- Install connectors.
- Connect the end terminals.



Note

The installation of cells and ribbed panels is always carried out from the outside to the inside (and as specified in the construction drawing). Any gap dimension corrections and unevenness on the outer walls are compensated with ribbed plates depending on the gap. This ensures a form-fit installation of the cells in the battery trays.

Insert ribbed plates in all gaps

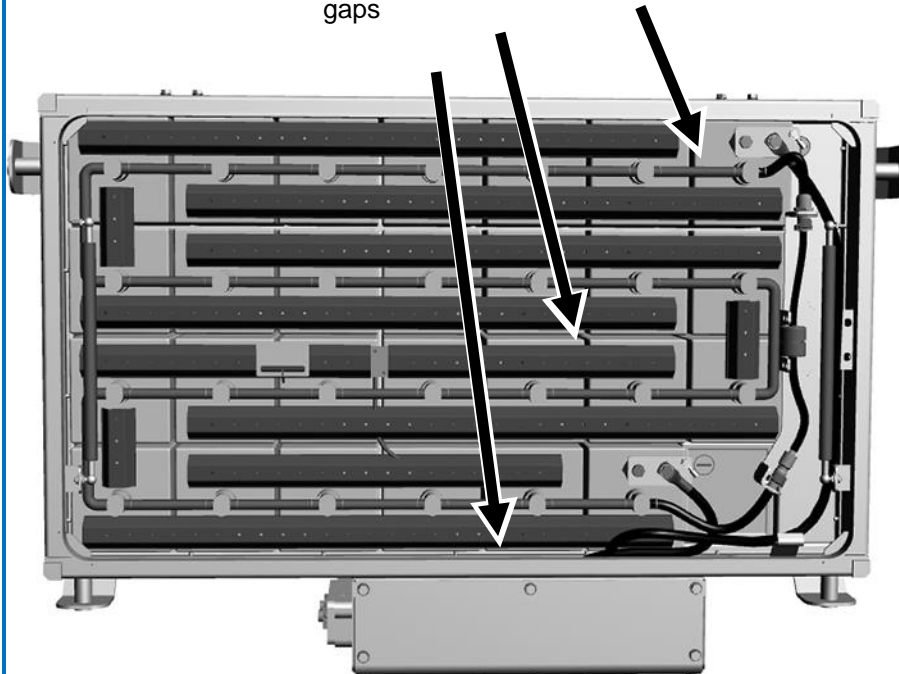

Note

The cells must be mounted on a flat surface (tray bottom). The maximum flatness tolerance is 3 mm in relation to the total area of the tray.



Note

When mounting cells in containers or carriers, the cells must not be "driven in". They must be inserted without applying any great force, otherwise the box/lid weld seam will be overloaded and leaks will occur.

**Note**

Observe the tightening torque when making the screw connections.

- M8 torque: 20 Nm \pm 1 Nm
- M10 torque: 25 Nm \pm 1 Nm
- Use new spring washers.

1. Connect the positive terminal of the battery to the positive terminal of the on-board power supply or charger.
2. Connect the negative terminal of the battery to the negative terminal of the on-board power supply or charger.
3. If available, connect control cables (e.g. temperature sensors, middle-voltage taps, etc.).
4. Check the battery connection, for example by checking the charging voltage and the control signals.

Result: The battery is now connected for use in the vehicle.

8.4. Recommissioning after test or parking operation

Experience has shown that long test and parking periods of more than 3 months can occur between the first commissioning of the batteries and the handover of the vehicle for regular operation. In such cases, a new commissioning charge must be carried out, see [8.2.2 Commissioning charge on page 39](#).

9. Maintenance

9.1. Preventive maintenance



Note

Observe the safety instructions, see [2 Safety instructions on page 11](#).

If you cannot carry out the maintenance yourself, have the batteries serviced regularly and properly by HOPPECKE qualified personnel or personnel authorised by HOPPECKE Batterie Systeme GmbH.

To ensure the optimal state of the battery system, follow the maintenance plan:

Activity	Interval	Description
Visual inspection	6 months	9.1.1 Perform visual inspection on page 47
Check electrolyte level	6 months	9.1.2 Checking the electrolyte level on page 48
Measuring the charge voltage	1 year *)	9.1.3 Measuring the charging voltage on page 50
Top up with distilled water		9.1.4 Fill up the electrolyte level with distilled water on page 52
Cleaning the battery		9.1.5 Cleaning the battery on page 55
Measurement of the insulation resistance		9.1.6 Testing the insulation resistance on page 56
Reconditioning charge		5 years *)
Replacement of the rail power FNC-HT cells and the attachments	15 years *)	11 Disassembly / Assembly on page 82

*) Intervals may vary depending on the project and/or the ambient temperature.



Note

In the event of a warranty claim, enter the activities and the measured values in a maintenance report, see [13.3 Maintenance protocol for HOPPECKE rail | power FNC-HT batteries on page 96](#).

9.1.1. Perform visual inspection

Target: The battery is visually inspected.

1. Inspect the battery against the following criteria:

Test object	Test criterion	Remedy
Contamination	Check battery cells, screws, connectors and cable lugs for dirt.	Thoroughly remove dirt from battery cells, screws, connectors and cable lugs with a clean, damp cloth, as dust and moisture can lead to leakage currents.
Ventilation	Check ventilation openings for free passage	Clear the ventilation openings.
Mechanical damage	Check battery and container for mechanical damage	Contact the depot manager or HOPPECKE Service.
Tight fit of connectors, screws and cables	Connectors, screws, cables must not be loose.	Tighten connectors, screws, cables.
Electrolyte level of the battery cells	The electrolyte level must be between the min and max mark.	If necessary top up with distilled water, see 9.1.4 Fill up the electrolyte level with distilled water on page 52
Tight fit of the temperature sensor	Check temperature sensor, if present, for proper mounting	Attach the temperature sensor properly.
Contamination by electrolyte	Plugs must be tight (no stains of electrolyte on the plugs or on the cells)	Check plugs for tight fit, correct if necessary.
Tight fit of the water refill system	Water refill systems must be correctly installed if present (no loose hoses or plugs).	Check hoses and plugs for tight fit, correct if necessary.
Seals	The seals of the container, if any, must not show any mechanical damage.	Replace damaged seals.

2. Enter your activities in a maintenance report, see [13.3 Maintenance protocol for HOPPECKE rail | power FNC-HT batteries on page 96](#).

Result: The visual inspection was completed.

9.1.2. Checking the electrolyte level

Target: The electrolyte level of the battery cells is checked.

When a battery is overcharged, electrolysis decomposes the electrolyte water into gases (H₂ and O₂). This causes the electrolyte level to drop. The amount of decomposed water depends on the charging voltage, the charging time per day and the temperature.



WARNING!

When checking the electrolyte level, contact with the electrolyte may occur.

There is a potentially hazardous medium-risk situation which, if not avoided, could result in death or serious injury.

The electrolyte can cause severe skin burns and eye damage.

Wear protective goggles and gloves when working on the batteries. (Five-finger latex or PVC gloves).

Required tools:

- measuring glass tube

Cells for use in railway vehicles often have flame-retardant polypropylene vessels (PP-V0) through whose walls the electrolyte levels are not visible. With translucent standard polypropylene vessels (PP) and polyethersulfone vessels (PES), individual electrolyte levels may not be visible due to the installation situation. In these cases, the measuring glass tube available from HOPPECKE (material number: 4144140010) must be used as an aid for electrolyte level control.

1. Open the vent plugs or remove the water refill plugs from 10% of the battery cells. For example, 8 cells in an 80 cell battery.

2. Keep the upper opening of the measuring glass tube free and insert it into the respective cell until it encounters resistance.
 - Close the upper opening of the measuring glass tube with your index finger.
 - Remove the measuring glass tube from the cell until the scale is visible.

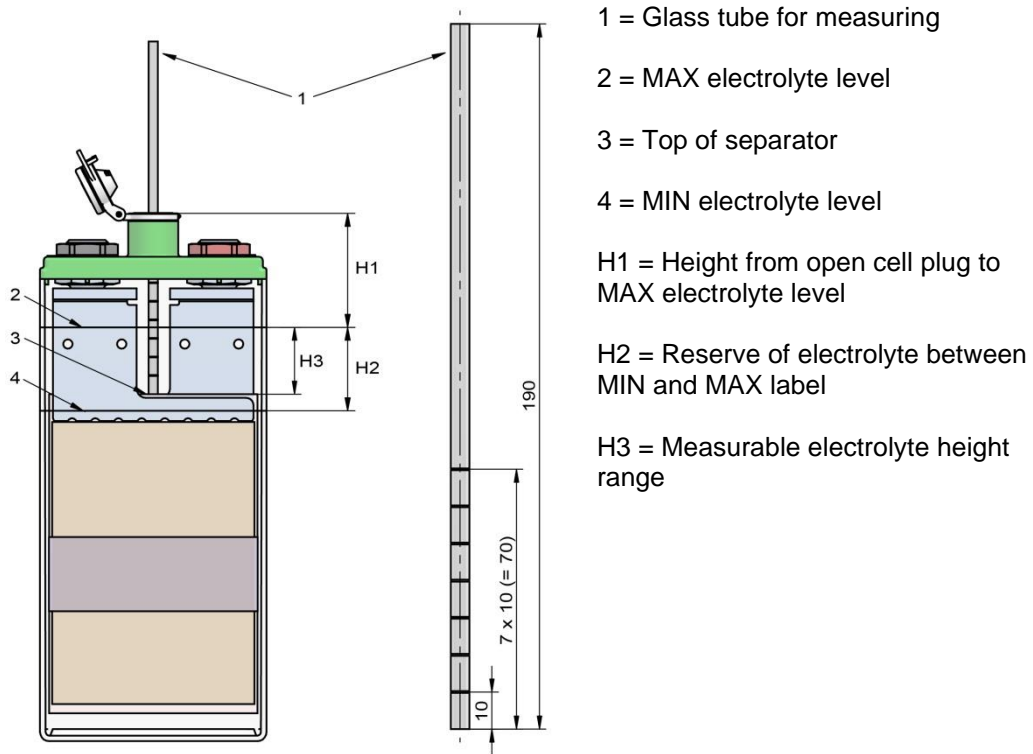

3. Read off the electrolyte level in the cell using the electrolyte remaining in the measuring glass tube and allow the electrolyte in the measuring glass tube to flow back into the cell.



Note

The rings count upwards from the lower edge of the measuring glass tube.

- If the electrolyte level is more than 2 rings (R2 and R3), no distilled water should be added. Continue with step 4.
- If the electrolyte level in one of the rail | power FNC-HT cells is less than or equal to 2 rings (R 2 and R3), top up distilled water to the maximum level. (see [9.1.4 Fill up the electrolyte level with distilled water on page 52](#))
- If the electrolyte levels of the rail | power FNC-HT cells differ by more than 2 rings, contact HOPPECKE Service.
- If the electrolyte level of one or more cells exceeds 5 rings (R2 and 3), contact the HOPPECKE service.

4. Close the vent plug again or insert the water refill plug again.
5. Enter your activities in a maintenance report, see [13.3 Maintenance protocol for HOPPECKE rail | power FNC-HT batteries on page 96](#).

Result: Now the electrolyte level of the battery cells has been checked.

9.1.3. Measuring the charging voltage

Target: The charging voltage of the battery is checked by measurement.

The controlled system temperature sensor-charger-battery is checked here. The measurement and logging of the measured charging voltage is used for error detection. For this purpose, the charging voltage is measured in float charge or boost charge and compared with the setpoint value.



DANGER!

When establishing access to the battery system, contact with sharp edges and/or live components may occur due to the design.

There is an immediate, high-risk hazard which, if not avoided, will result in death or serious injury.

Measures to avert the danger:

- - Be very careful when carrying out any work on the batteries.
- - Wear personal protective equipment, see [2 Safety instructions on page 11](#).



Pre-condition

The battery system is connected to the vehicle's onboard charger and is being charged.

Required tools:

- Digital Multimeter
- current clamp
- contact thermometer

1. Measure the charging voltage of the battery system with a suitable multimeter.
2. Measure the charging current of the battery system with a suitable current clamp.
3. Measure the temperature of the battery system with a suitable thermometer (e.g. contact thermometer).
4. Check the measured value against the charging characteristic, see [5.6 Temperature compensation on page 26](#).

It applies:

	Measured Current (I)	Measured Voltage
Battery	< I ₂₀	Float-Charge
	More than I ₂₀ but lower (1.5 x I ₅)	Boost-Charge
	≥ (1.5 x I ₅)	I-Phase; no statement possible. Wait until U = const, i.e. until Boost- or Float-Charging is available

Example using an rail | power FNC-HT cell of power class M:

For rapid charging, a cell voltage of 1.60 V at 20 °C must be measured.



Note

If the measured voltage deviates from the setpoint by more than $\pm 1.5\%$, troubleshoot the temperature sensor or charger.

5. Enter your activities in a maintenance report, see [13.3 Maintenance protocol for HOPPECKE rail | power FNC-HT batteries on page 96](#).

Result: The charging voltage of the battery has been checked.

9.1.4. Fill up the electrolyte level with distilled water

Target: The battery is refilled with distilled water.



WARNING!

When checking the electrolyte level, contact with the electrolyte may occur.

There is a potentially hazardous medium-risk situation which, if not avoided, could result in death or serious injury.

The electrolyte can cause severe skin burns and eye damage.

Wear protective glasses and gloves (five-finger latex or PVC gloves) when working on the batteries.



Note

Always check the electrolyte level before this maintenance step, see [9.1.2 Checking the electrolyte level on page 48](#).



Note

- Filling with acid destroys the rail | power FNC-HT cells.
- Tap water is not allowed and will affect your battery performance.
- Only use distilled / deionised water according to EN 60993 or DIN 43530-4 to refill the rail | power FNC-HT cells.

The refilling of distilled water can be done with 3 different methods:

Method	Description
Fill up water manually	9.1.4.1 Fill up distilled water manually on page 53
Fill up water with the central water refill system	9.1.4.2 Refill distilled water with the central water refilling system on page 53
Fill up water with the water refill cart for single cells	9.1.4.3 Refill distilled water with the water refill cart for single cells on page 54

Result: The electrolyte levels of the battery are filled with distilled water.

9.1.4.1. Fill up distilled water manually

Required tools:

- measuring glass tube
- funnel or pipette for filling the distilled water into the cells

1. Open all vent plugs.
2. Fill each rail | power FNC-HT cell with distilled water to maximum level.

For the cell types R2 and R3 (the type information is a part of the cell designation, see label on each cell), observe the following table when refilling distilled water:

Battery cell format	Maximum electrolyte level according to measuring glass tube [mm]
R 2	36 ± 2 (3.5 rings)
R 3	

3. Close all vent plugs.
4. Clean the battery system if necessary, see [9.1.5 Cleaning the battery on page 55](#).
5. Enter your activities in a maintenance report, see [13.3 Maintenance protocol for HOPPECKE rail | power FNC-HT batteries on page 96](#).

9.1.4.2. Refill distilled water with the central water refilling system



Note

If a water refill system is installed on the battery, the following applies:

Fill up distilled water with the central water refill system. Instructions are described in the following document:

D00001-300-en<version number>-Water-Refilling.pdf

Enter your activities in a maintenance report, see [13.3 Maintenance protocol for HOPPECKE rail | power FNC-HT batteries on page 96](#).

9.1.4.3. Refill distilled water with the water refill cart for single cells



Note

If a water refill cart for single cells is available, the following applies:

Refill distilled water with the single cell water refill cart. Instructions are described in the following document:

D00003-300-en<Version number>_Manual_SemiAutomaticWaterfilling.pdf

Enter your activities in a maintenance report, see [13.3 Maintenance protocol for HOPPECKE rail | power FNC-HT batteries on page 96](#).

9.1.5. Cleaning the battery

Target: The battery is cleaned.

A clean battery is essential to avoid accidents and property damage, as well as shortened life and availability.

Cleaning the rail | power FNC-HT cells and the tray or container is necessary to maintain the necessary insulation of the cells against each other, against earth or foreign conductive parts. Damage caused by corrosion and leakage currents is also avoided.

Cleaning the battery is not only necessary to ensure high availability, but is also an essential part of accident prevention regulations.



Note

Improper cleaning may damage the batteries.

Avoid damaging the battery:

- Do not use solvents or wire brushes for cleaning.
- Prevent penetration of cleaning water and dirt particles into the cells. The vent plugs must be closed.

1. Clean the battery with a clean cloth and with water without adding any detergents or cleaning agents.
2. Let the surfaces dry or use compressed air.



Note

Any liquids which entered the battery tray must be extracted and disposed of in accordance with waste monitoring guidelines.

3. Enter your activities in a maintenance report, see [13.3 Maintenance protocol for HOPPECKE rail | power FNC-HT batteries on page 96](#).

Result: The battery is now cleaned.

9.1.6. Testing the insulation resistance

Target: The insulation resistance of the battery is measured.

The insulation resistance of a battery in the rolling stock is a measure of the conductivity between the battery terminal posts and the chassis of the vehicle. The conductivity is a result of moisture and contamination of the battery between the battery terminal posts and the chassis of the rolling stock vehicle. Ideally, no conductivity should take place here. The ideal insulation resistance of the battery should be infinitely large.

When commissioning a new battery, the insulation resistance must be $> 1 \text{ M}\Omega$. It decreases with the operating time (due to aerosols from the batteries, condensation, dust) and may not fall below the following values depending on the nominal battery voltage:

Battery nominal voltage	Norm	Insulation Resistance (minimum value)
below 100 V	DIN VDE 0119-206-4	10 k Ω
between 100 V and 120 V	DIN EN IEC 62485-2	100 Ω per Volt nominal voltage
Above 120 V, i.e. from 100 cells	DIN EN 62485-3 09/2015	Number of cells x 1.2 V nominal voltage x 500 Ohm/V

If this minimum value is not reached, a possibly existing insulation monitor may detect an error, an undesired increased discharge and loss of battery performance may occur.



Note

For rail | power FNC-HT batteries, an insulation test instrument with a test voltage of 500 V must be used.

Use a suitable measuring device, e.g., Fluke 1507 (HOPPECKE Mat.nr.: 4141201237), with the setting 500 V/DC



CAUTION!

Risk of damage to the on-board network of the vehicle.

An insulation test voltage of 500 V may damage other components connected to the battery.

Disconnect the battery from the on-board network, positive and negative terminal.



WARNING!

When carrying out measurements with an insulation measuring instrument, there is a risk of electric shock.

There is a potential medium risk which, if not avoided, could result in death or serious injury.

Observe the safety precautions described in the documentation of the insulation measuring instrument.

Required tools:

- Insulation measuring instrument (e.g. Fluke 1507)

1. Check the function of the insulation measuring device by measuring any metal part of the battery tray / battery container against any metal part of the vehicle chassis. The measured resistance must be 0 Ohm.
2. Measure the insulation resistance between positive terminal of the battery and one metallic part of the rolling stock vehicle chassis (battery compartment or central earthing point).
3. Measure the insulation resistance between the negative terminal and a metallic part of the rolling stock vehicle chassis.
4. Check the function of the insulation measuring device by measuring any metal part of the battery tray / battery container against any metal part of the vehicle chassis. The measured resistance must be 0 Ohm.
5. Clean the battery if the measurements fall below the minimum value (see [9.1.5 Cleaning the battery on page 55](#)).
6. Measure insulation resistances again according to steps 2 and 3.

**Note**

If the isolation test fails again, contact HOPPECKE service.

7. Enter your activities in a maintenance report, see [13.3 Maintenance protocol for HOPPECKE rail | power FNC-HT batteries on page 96](#).

Result: The insulation resistance of the battery is now measured.

9.1.7. Reconditioning

Reconditioning can eliminate or reduce capacity losses of a battery system. It is carried out by repeatedly discharging/charging of the battery system with constant current.



DANGER!

Danger of explosion due to formation of oxyhydrogen gas!

Water is decomposed during the commissioning charge of the batteries, during reconditioning and during charging in train operation. This can lead to the formation of a hydrogen-oxygen gas mixture (oxyhydrogen gas), which explodes even at low energy input.

Keep any source ignition away from the battery system:

- Open flames or fire
- Smoking
- Glowing embers
- Flying sparks during grinding work
- Electrical sparks caused by switches or fuses
- Hot surfaces with temperature above 300°C
- Electrostatic discharges

Work with electrically insulated tools that do not create sparks.

Ground yourself when working directly on the battery system.

Make sure that there is adequate ventilation in the battery room in accordance with DIN EN IEC 62485-2, so that the potential explosive gas mixture is discharged.



WARNING!

When checking the electrolyte level, contact with the electrolyte may occur.

There is a potentially hazardous medium-risk situation which, if not avoided, could result in death or serious injury.

The electrolyte can cause severe skin burns and eye damage.

Wear protective glasses and gloves (five-finger latex or PVC gloves) when working on the batteries.



Note

- Carry out reconditioning when the battery system is uninstalled, i.e. mechanically separated from the vehicle
- Recondition in an air-conditioned working area at 20 °C (±5 °C).



Note

The reconditioning charge is a constant current charge, see [5.5.1 Charging with constant current \(I\)](#) on page 23.

Required tools:

- suitable charging/discharging equipment
- measuring glass tube
- digital Multimeter
- gas venting tube
- torque wrench with matching wrench sizes for M8/M10 screws
- contact thermometer

For reconditioning, the battery is supplied with an electric charge of 1.5 Cn, where relatively high cell voltages can arise while charging (up to 1.9 V). For example, a battery charging voltage of 152 V may occur with an 80 cell battery.

Perform the following activities in the order given here:

Activity	Description
Prepare reconditioning	9.1.7.1 Preparation on page 60
Execute reconditioning	9.1.7.2 Execution on page 62
After reconditioning	9.1.7.3 Follow-up work on page 65

9.1.7.1. Preparation

Target: The cells are prepared for reconditioning.

1. Remove the vent plugs or the water refill plugs and their tubing from each rail | power FNC-HT cell.
2. Clean the vent plugs or the water refill system in warm water, i.e. place it in warm water and allow it to act during the reconditioning period. Then rinse with fresh water.
3. Remove the insulation profiles on the connectors.

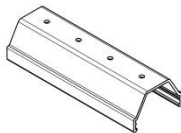

4. Clean the insulation rails with warm water.
5. Measure the electrolyte level in each cell with the measuring glass tube (HOPPECKE material number: 4144140010).
 - Keep the upper opening of the measuring glass tube free and insert it into the cell until it encounters resistance.
 - Close the upper opening of the measuring glass tube with your index finger.
 - Remove the measuring glass tube from the cell until the scale is visible.

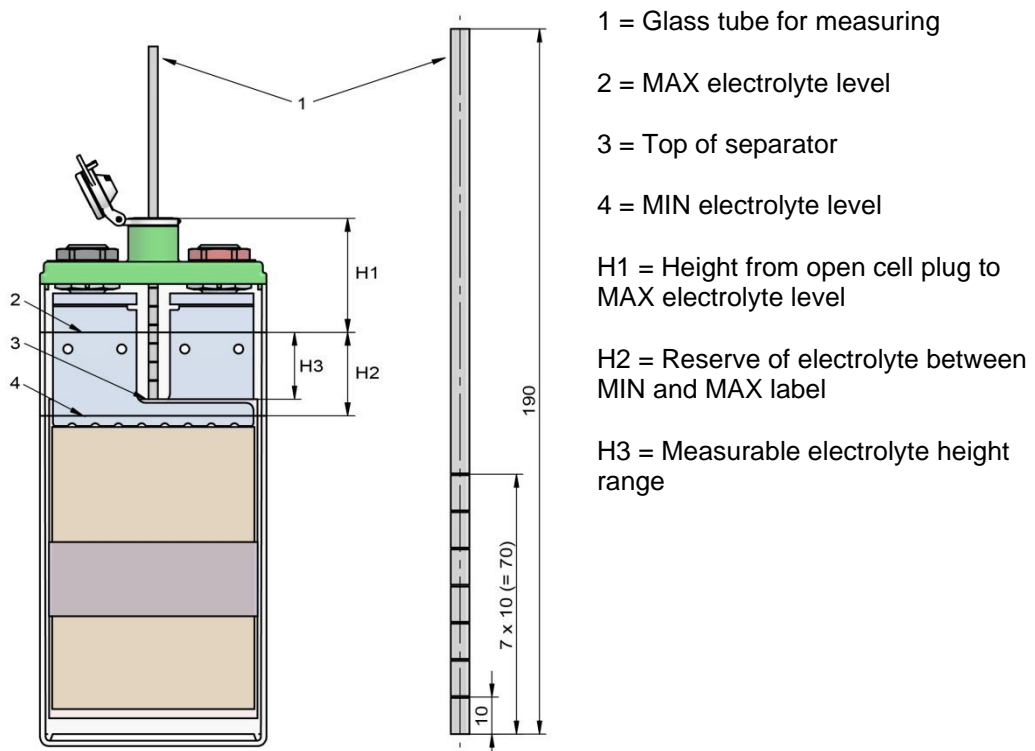

6. Read off the electrolyte level in the cell from the electrolyte remaining in the measuring glass tube and allow the electrolyte in the measuring glass tube to flow back into the cell.

Note for FNC-Cells in format 2 and 3

- If the electrolyte level of one or more cells is higher than 4 rings (counted from bottom to top):
 - take the battery out of service
 - contact the HOPPECKE Service.
- The electrolyte level must be at least 1.5 rings. If necessary, fill the cell up to this level with distilled water.
 - Continue with the reconditioning, see step 7.
- If the electrolyte levels in the rail | power FNC-HT cells are above 3.5 but below 4 rings:
 - Continue with reconditioning, see step 7.
 - greater contamination (ejection of electrolyte) must be expected.
 - Prevent contamination by laying out with a highly absorbent paper towel.
- If the electrolyte levels of the selected rail | power FNC-HT cells are equal to or below 3.5 rings:
 - Continue with reconditioning, see step 7.

7. Measure the individual cell voltages with a digital multimeter and record the values in a maintenance report.

Note

If the open circuit voltage of a cell is < 1.2 V, contact HOPPECKE service.

8. Insert a gas venting tube (HOPPECKE material number: 4143180110) on each rail | power FNC-HT cell.

9. Connect the charger/discharger to the main terminals of the battery.

Note

- M8 Torque: $20 \text{ Nm} \pm 1 \text{ Nm}$
- M10 Torque: $25 \text{ Nm} \pm 1 \text{ Nm}$
- Use new spring washers.

Result: Now the cells are prepared for reconditioning. Continue with the execution.

9.1.7.2. Execution

Target: The cells are reconditioned.

The following graphic illustrates the steps necessary for reconditioning:

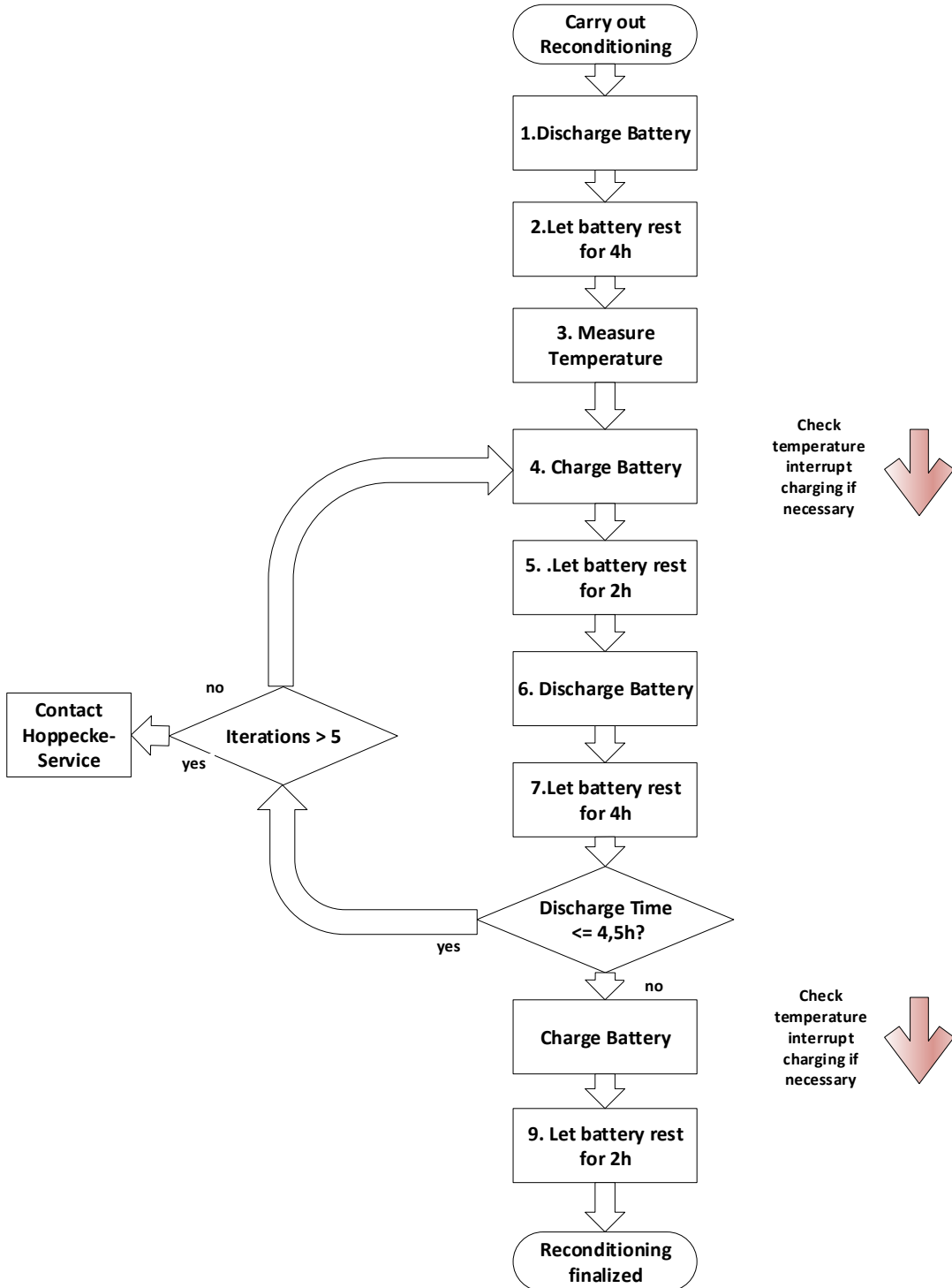

The individual steps are described in detail in the following instructions:

1. Discharge the battery at rated current I_5 until the voltage of the battery has dropped to 1.0 V per cell, e.g. 80 V for an 80 cell battery.
2. Let the unloaded battery rest for at least 4 hours, preferably overnight.
3. Measure the temperature of the battery, e.g. with a contact thermometer.
The cell to be measured should be installed in the middle of the system in order to detect the warmest part of the system.
Record the measured value.
4. Charge the battery at constant current I_5 for 7.5 hours.



Note

The battery must not exceed a temperature of 45 °C during charging.

If a temperature of 45 °C is reached, interrupt charging.

Note the remaining charging time.

Do not continue charging until the cell temperature has dropped to 25 °C.

Complete the charging time of 7.5 hours after the battery has cooled down.

If the battery reaches a temperature of 45 °C again before the 7.5 hour charging time has been completed, interrupt charging again, etc.

5. Let the battery rest for 2 hours.
6. Discharge the battery at rated current I_5 until the voltage of the battery has dropped to 1.0 V per cell and measure the time. This is the capacity test.



Note

If the battery system takes 5 hours to drop to 1.0 V per rail | power FNC-HT rail cell its capacity is 100 %. It applies:

- 5 hours -> 100 %
- 4.5 hours -> 90 %
- 4 hours -> 80 %
- 3,5 hours -> 70 %

...

7. Let the battery rest for at least 4 hours, preferably overnight.
If the discharge time is ≤ 4.5 hours, repeat the procedure from point 4.



Note

If the discharge time is still ≤ 4.5 hours after 5 repetitions of this procedure, contact HOPPECKE service.

8. Charge the battery at constant current I_5 for 7.5 hours.

**Note**

The battery must not exceed a temperature of 45 °C during charging.

If a temperature of 45 °C is reached, interrupt charging.

Note the remaining charging time.

Do not continue charging until the cell temperature has dropped to 25 °C.

Complete the charging time of 7.5 hours after the battery has cooled down.

If the battery reaches a temperature of 45 °C again before the 7.5 hour charging time has been completed, interrupt charging again, etc.

9. Let the battery rest for 2 hours.

Result: The cells are now reconditioned. Continue with the follow-up work.

9.1.7.3. Follow-up work

Target: The cells are made ready for operation again after reconditioning.

1. Disconnect the charger/discharger from the battery.
2. Remove the gas venting tubes.
3. Check the electrolyte level at each cell and manually fill the electrolyte level to the maximum with distilled water, see [9.1.4.1 Fill up distilled water manually on page 53](#).
4. Thoroughly remove any impurities from the battery with a clean, damp cloth.
5. Measure and record the individual cell voltages with a digital multimeter.



Note

If the individual cell voltages vary by more than ± 50 mV from the mean of all cell voltages, contact HOPPECKE service.

6. Mount the insulation profiles.
7. Insert the vent plugs or the water refill plugs back into each rail | power FNC-HT cell.
8. Restore the hose system of the water refilling system, if present.
9. Measure the insulation resistance of the battery, see [9.1.6 Testing the insulation resistance on page 56](#).
10. Enter your activities in a maintenance report, see [13.3 Maintenance protocol for HOPPECKE rail | power FNC-HT batteries on page 96](#).

Result: The cells are now ready for operation again and can be installed in the vehicle.

9.2. Corrective maintenance



Note

Observe the safety instructions, see [2 Safety instructions on page 11](#).

9.2.1. Change of rail | power FNC-HT cells



DANGER!

When establishing access to the battery system, contact with sharp edges and/or live components may occur due to the design.

There is an immediate, high-risk hazard which, if not avoided, will result in death or serious injury.

Measures to avert the danger:

- Be very careful when carrying out any work on the batteries.
- Wear personal protective equipment, see [2.2 Personal protective equipment on page 16](#).



DANGER!

Loose connections on the terminal screws can become very hot and cause inflammation or explosions.

Use each spring washer only once.

- First tighten the terminal screws by hand only.
- Align batteries and connectors again if necessary.
- Then tighten the terminal screws to the prescribed torque.



Note

- Switch off all consumers and chargers from the battery system before starting maintenance work.
- A battery always has a voltage at the terminals.
- A battery must not be earthed or short-circuited.
- Batteries are very heavy. Carry the battery carrier with a sufficient number of persons or use suitable lifting equipment and means of transport.

If rail | power FNC-HT cells are defective, you can replace a maximum of 10% of the total number of cells in the entire battery system with new, unused cells of the same type. If more cells are defective, all cells must be replaced.

**Note**

The mixing of cells from different used batteries into one total battery is not allowed.

The exchange cells must be cells in a charged state. The lid code of the cells must be observed:

- If the cells have been manufactured within the last 3 months, no commissioning charge is required. Replace the cells to be replaced as described under **Fehler! Verweisquelle konnte nicht gefunden werden. Fehler! Verweisquelle konnte nicht gefunden werden. on page Fehler! Textmarke nicht definiert..**
- If stored cells older than 3 months are used, a commissioning charge must first be carried out for these cells, see [9.2.1.1 Prepare the rail | power FNC-HT cell\(s\) to be replaced on page 67.](#)

The date of manufacture of the rail | power FNC-HT cells is stamped on the top of each cell. Each cell has a 9-digit cell code at the top of the cell cover. The last four digits indicate the production week and year.

Example: xxxxx2619 => production week 26; production year 2019

9.2.1.1. Prepare the rail | power FNC-HT cell(s) to be replaced

Target: The new exchange cells are prepared for operation in the vehicle.

Required tools:

- suitable charging/discharging equipment
- measuring glass tube
- digital Multimeter
- gas venting tube
- torque wrench with matching wrench sizes for M8/M10 screws
- contact thermometer

1. Measure the individual cell voltages of the exchange cells with a digital multimeter and record the values in a test report.

**Note**

If the open-circuit voltage of a cell < 1.2 V, contact the HOPPECKE service.

2. Connect exchange cells in series with suitable connecting cables or cell connectors.

**Note**

Use a suitable cable to connect the cells:

- M8 or M10 cable lug
- M8: 20 Nm Tightening torque / M10: 25 Nm Tightening torque
- Use new spring washers.

3. Attach a gas venting tube to each exchange cell (HOPPECKE material number: 4143180110).
4. Connect the exchange cells connected in series with a suitable charger/discharger.



Note

Use a suitable cable to connect the charger/discharger:

- M8 or M10 cable lug
- M8: 20 Nm Tightening torque / M10: 25 Nm Tightening torque
- Use new spring washers

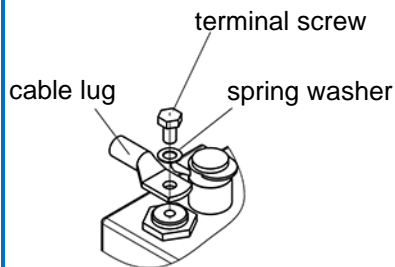

5. Discharge exchange cells using the discharger with rated current I_5 until the voltage has dropped to 1.0 V per cell.
6. Allow load-free exchange cells to rest for at least 4 hours.
7. Measure the temperature of at least one of the exchange cells.
8. Charge exchange cells with constant current I_5 for 7.5 hours.



Note

The battery must not exceed a temperature of 45 °C during charging.

If a temperature of 45 °C is reached, interrupt charging.

Note the remaining charging time.

Do not continue charging until the cell temperature has dropped to 25 °C.

Complete the charging time of 7.5 hours after the battery has cooled down.

If the battery reaches a temperature of 45 °C again before the 7.5 hour charging time has been completed, interrupt charging again, etc.

9. Allow exchange cells to rest for at least 4 hours, preferably overnight.
10. Disconnect the charger/discharger from the exchange cells.
11. Remove the gas venting tubes.
12. Manually fill up the distilled water of the exchange cells to the maximum, see [9.1.4.1 Fill up distilled water manually on page 53](#).

13. Remount the vent plugs or water refilling plugs.
14. Thoroughly remove any contamination from the battery with a clean, damp cloth.
15. Measure the individual cell voltages with a digital multimeter and record the values in a test report.

Result: The exchange cells are now prepared for operation in the vehicle.

9.2.1.2. Replace one or more rail | power FNC-HT cell(s)

Target: The defective cells are replaced with new exchange cells.

Required tools:

- - digital multimeter
- - cell lifter
- - torque wrench with matching wrench sizes for M8/M10 screws

1. Disconnect chargers and loads from the battery system.
2. Open the battery container, if available.
3. Remove the insulating profiles.
4. If available, remove the tubing of water refilling system.
5. Remove the cell connectors. (M8 / M10 screws)



Note

To lift the cell, use the Hoppecke cell lifter. (M8: HOPPECKE material number: 4141900002 / M10: HOPPECKE material number: 4141900003).

6. Remove the cell from the container / tray.
7. Remove the vent plug or water refill plug of the cell to be replaced and mount it on the replacement cell.

8. Install the exchange cell in the container / tray.

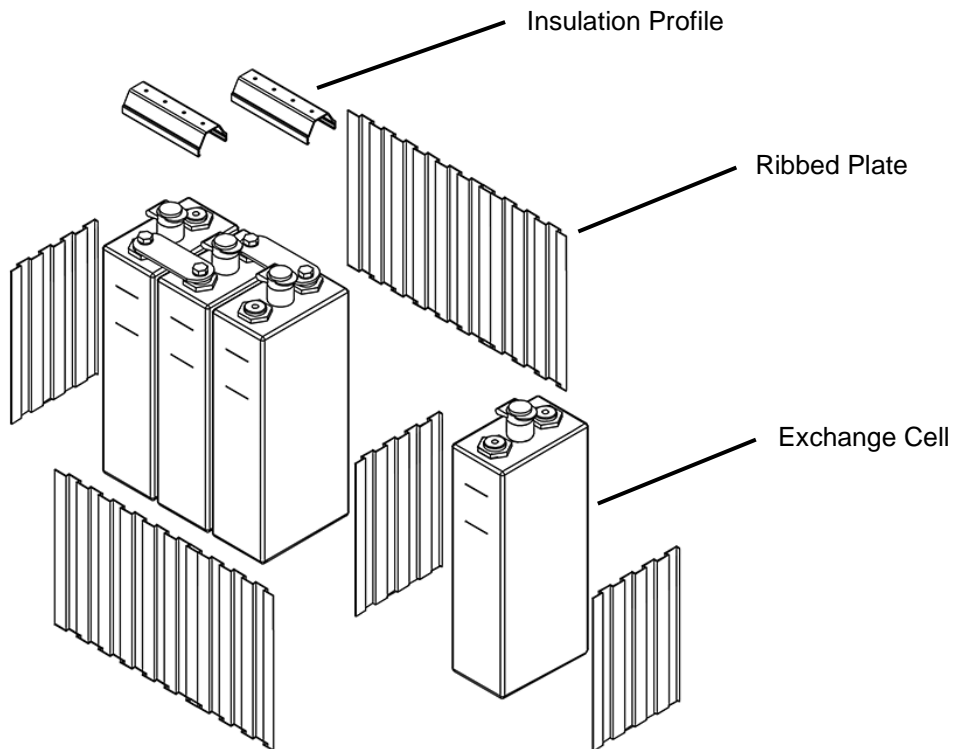
**Note**

If the exchange cells are older than 3 months, preparation must be carried out before, see [9.2.1.1 Prepare the rail | power FNC-HT cell\(s\) to be replaced on page 67](#).

**Note**

The date of manufacture of the rail | power FNC-HT cells is stamped on the top of each cell. Each cell has a 9-digit cell code on top of the cell lid. The last four digits give information about the production week and the production year.

Example:

xxxxx2610 => Production week 26; Production year 2010

9. Install the cell connectors.

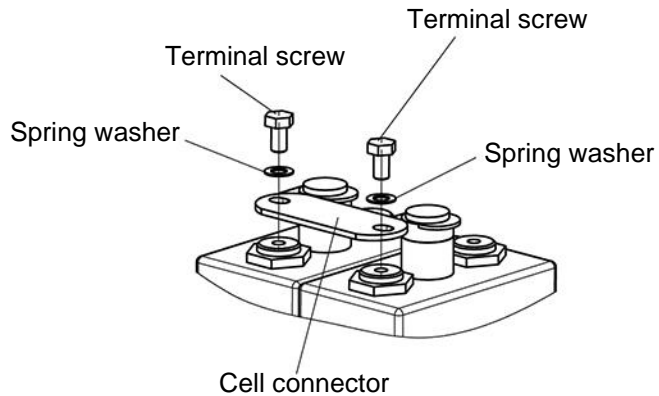

Note

- M8 Torque: 20 Nm \pm 1 Nm
- M10 Torque: 25 Nm \pm 1 Nm
- Use new spring washers.

10. Install the insulating profiles.

11. Reinsert the vent plug or water refill plug and install the tubing.

12. Check the total voltage of the battery.



Note

If the total voltage is less than the number of cells x 1.2 V, contact HOPPECKE Service.

13. Document exchange and number of cells.

Result: Now the defective cells have been replaced by new exchange cells.

9.2.2. Exchange of the temperature sensor

Target: A defective temperature sensor is replaced with a new one.



DANGER!

When establishing access to the battery system, contact with sharp edges and/or live components may occur due to the design.

There is an immediate, high-risk hazard which, if not avoided, will result in death or serious injury.

Measures to avert the danger:

- Be very careful when carrying out any work on the batteries.
- Wear personal protective equipment, see [2.2 Personal protective equipment on page 16](#).



Note

- Switch off all consumers and chargers from the battery system before starting maintenance work.
- A battery always has a voltage at the terminals.
- A battery must not be earthed or short-circuited.
- Batteries are very heavy. Carry the battery carrier with a sufficient number of persons or use suitable lifting equipment and means of transport

Required tools:

- torque wrench with matching wrench sizes for M4 and M8/M10 screws

1. Disconnect the plug connection of the temperature sensor.
2. If available, remove the water refilling tube above the affected cell connector.
3. Remove the insulation profile above the affected cell connector.
4. Remove the cell connector.
5. Remove the temperature sensor from the cell connector by loosening the M4 screws.
6. Mount a new temperature sensor on the cell connector (torque: 2 Nm)
7. Mount the cell connector.



Note

- M8 Torque: 20 Nm \pm 1 Nm
- M10 Torque: 25 Nm \pm 1 Nm
- Use new spring washers.

8. Mount the insulation profile.
9. Reinstall the water refilling tubes if available.
10. Connect the plug connection of the temperature sensor.
11. Check charge voltage, see [9.1.3 Measuring the charging voltage on page 50](#).

Result: Now the defective temperature sensor has been replaced with a new one.

9.2.3. Exchanging a cell connector

Target: A defective cell connector is replaced with a new cell connector.



DANGER!

When establishing access to the battery system, contact with sharp edges and/or live components may occur due to the design.

There is an immediate, high-risk hazard which, if not avoided, will result in death or serious injury.

Measures to avert the danger:

- Be very careful when carrying out any work on the batteries.
- Wear personal protective equipment, see [2.2 Personal protective equipment on page 16](#).



DANGER!

Loose connections on the terminal screws can become very hot and cause inflammation or explosions.

Use each spring washer only once.

- First tighten the terminal screws by hand only.
- Align batteries and connectors again if necessary.
- Then tighten the terminal screws to the prescribed torque.



Note

- Switch off all consumers and chargers from the battery system before starting maintenance work.
- A battery always has a voltage at the terminals.
- A battery must not be earthed or short-circuited.
- Batteries are very heavy. Carry the battery carrier with a sufficient number of persons or use suitable lifting equipment and means of transport

Required Tools:

- torque wrench with matching wrench sizes for M8/M10 screws

1. If available, remove the water refilling tube above the affected cell connector.
2. Remove the insulation profile of the affected cell connector.

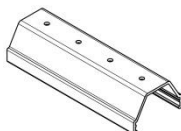

3. Remove the terminal screws.
4. Remove the defective cell connector.

5. Install a new cell connector.

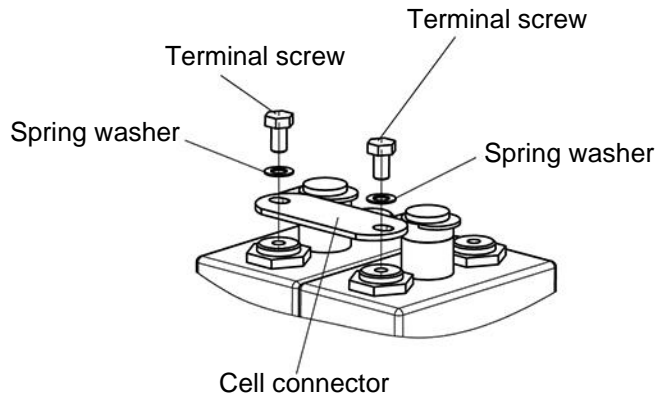

Note

- M8 Torque: 20 Nm \pm 1 Nm
- M10 Torque: 25 Nm \pm 1 Nm
- Use new spring washers.

6. Install the insulation profile.
7. If available, install the water refilling tube.

Result: The defective cell connector has now been replaced with a new cell connector.

10. Troubleshooting



Note

Observe the safety instructions, see [2 Safety instructions on page 11](#).

10.1. Insufficient capacity

If the capacity of the battery system is too low, proceed as follows:

Cause	Remedy
Charging process too short	Check onboard Charger, Perform a reconditioning charge
Different Electrolyte levels	Correct electrolyte level
Loose or oxidised terminal(s)	Check all connector(s), replace the connector(s) if required (use new spring washer(s))
Excessive cyclisation (many charge- / deep discharge cycles)	Perform a reconditioning charge
Temperature sensor has a defect. That causes incorrect charge parameters.	Check the temperature sensor if available, see 10.5 Malfunction of the temperature sensor on page 79 .

10.2. Insufficient insulation resistance

When commissioning a new battery, the insulation resistance must be $> 1 \text{ M}\Omega$. It decreases with the operating time (due to aerosols from the batteries, condensation, dust) and may not fall below the following values depending on the nominal battery voltage:

Battery nominal voltage	Norm	Insulation Resistance (minimum value)
below 100 V	DIN VDE 0119-206-4	10 k Ω
between 100 V and 120 V	DIN EN IEC 62485-2	100 Ω per Volt nominal voltage
Above 120 V, i.e. from 100 cells	DIN EN 62485-3 09/2015	Number of cells x 1.2 V nominal voltage x 500 Ohm/V

If these minimum values are not reached, a possibly existing insulation monitor of the vehicle may response, an undesired increased discharge and loss of battery performance may occur.

If the insulation resistance is too low, leakage currents can reduce the available capacity. This can also cause differences in voltage between the cells. Regular cleaning prevents these leakage currents.

Cause	Remedy
Contamination	Cleaning
rail power FNC-HT cell(s) is/are leaking	Remedy the problem or replace the cell if necessary
Water refilling system is leaking	Remedy the problem or replace the plugs/hoses if necessary

10.3. No battery voltage can be measured

If no battery voltage can be measured, proceed as follows:

Cause	Remedy
Main plug of the battery system is not inserted	Connect the main plug
Main plug of the battery system is defect	Replace the main plug
Cable breakage	Replace the cable
Cell connector(s) is/are defect	Replace the connector(s) (use new spring washer(s))

10.4. Malfunction of the water refilling system

- if available -

If malfunctions arise during refilling of water, proceed as follows:

Effect	Cause	Remedy
Cells are not refilled	Dirt in the water refilling plug(s)	Clean water refilling plug(s) with warm water or replace it/them if necessary. Then check all cells manually and refill distilled water manually to ensure an even level in all cells. At the next maintenance interval, you can use the water refill system again for refilling.
Water leakage during refilling	The connection between the hose and the water refilling plug is faulty / water leakage during refilling	Check connection and replace water refilling plug and/or hose if necessary
	O-rings are damaged or shifted	Replace O-rings
Cell(s) is/are filled above maximum level	Operating error during the refilling of water Note: Start the filling operation only once a maintenance interval. You overfill the cells if you start the filling operation many successive times, comparable with the filling process of a fuel tank of a car that can be overfilled.	-
	A hose is bent	Remedy the cause of the problem.
	The return line of the water refilling cart is not connected	Connect the water refilling cart correctly.
	There are one or more leaking cells	Remedy the cause of the problem, replace the cell(s) if necessary
	O-rings are damaged or shifted	Replace O-rings



Note

If cells are filled above the maximum level, contact the HOPPECKE service.

10.5. Malfunction of the temperature sensor

If the temperature sensor does not provide plausible temperature values, the battery may be undercharged or overcharged. Compare the measured charging voltages and the measured temperature values, see [5.6 Temperature compensation on page 26](#).

A defect of the temperature sensor can be detected by a resistance measurement with simultaneous temperature measurement using the data sheet of the temperature sensor (e.g., Ntc 10k => 10 kΩ @ 20 °C).

Proceed as follows:

Possible Cause	Remedy
Temperature sensor defect	<p>Replace the temperature sensor, see 9.2.1.2 Replace one or more rail power FNC-HT cell(s)</p> <p>Target: The defective cells are replaced with new exchange cells.</p> <p>Required tools:</p> <ul style="list-style-type: none"> • - digital multimeter • - cell lifter • - torque wrench with matching wrench sizes for M8/M10 screws <p>8. Disconnect chargers and loads from the battery system.</p> <p>9. Open the battery container, if available.</p> <p>10. Remove the insulating profiles.</p> <p>11. If available, remove the tubing of water refilling system.</p> <p>12. Remove the cell connectors. (M8 / M10 screws)</p> <div style="border: 1px solid blue; background-color: #0070C0; color: white; padding: 2px; margin: 10px 0;">  <p>Note</p> <p>To lift the cell, use the Hoppecke cell lifter. (M8: HOPPECKE material number: 4141900003).</p> </div> <p>13. Remove the cell from the container / tray.</p> <p>14. Remove the vent plug or water refill plug of the cell to be replaced and mount it on the replacement cell.</p> <p>15. Install the exchange cell in the container / tray.</p>

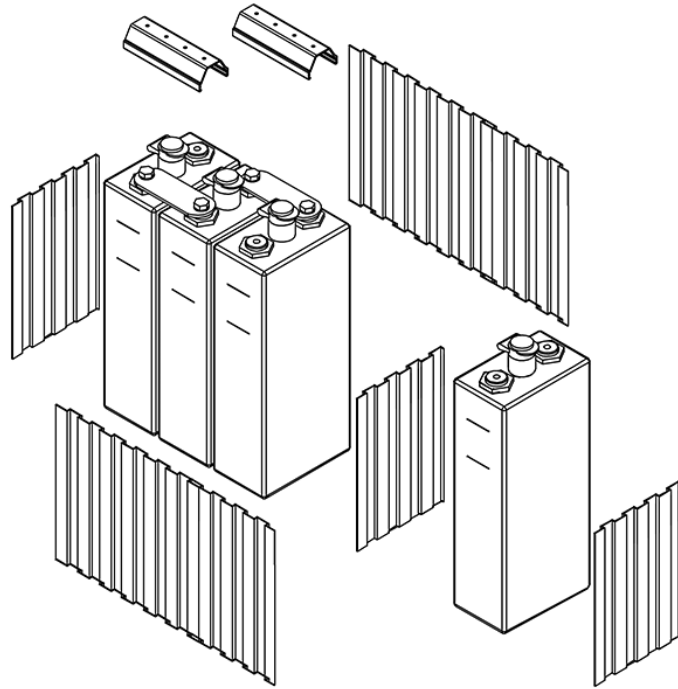

Note

If the exchange cells are older than 3 months, preparation must be
[9.2.1.1 Prepare the rail | power FNC-HT cell\(s\) to be replaced on p](#)



Note

The date of manufacture of the rail | power FNC-HT cells is stamp
 Each cell has a 9-digit cell code on top of the cell lid. The last four
 the production week and the production year.



Example:

xxxxx2610 => Production week 26; Production year 2010

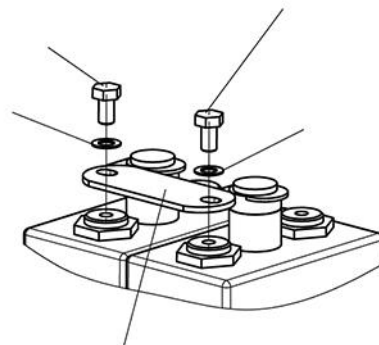
16. Install the cell connectors.



Note

	<div style="border: 1px solid blue; padding: 5px; margin-bottom: 10px;">  <ul style="list-style-type: none"> M8 Torque: 20 Nm ± 1 Nm M10 Torque: 25 Nm ± 1 Nm Use new spring washers. </div> <p>17. Install the insulating profiles. 18. Reinsert the vent plug or water refill plug and install the tubing. 19. Check the total voltage of the battery.</p> <div style="border: 1px solid blue; padding: 5px; margin-bottom: 10px;">  <div style="background-color: #0070C0; color: white; padding: 2px;">Note</div> <p>If the total voltage is less than the number of cells x 1.2 V, contact</p> </div> <p>20. Document exchange and number of cells. Result: Now the defective cells have been replaced by new exchange cells.</p> <p>Exchange of the temperature sensor on page 69</p>
Plug defective	Replace plug
Plug not inserted	Insert plug
Cable breakage in the extension cable	Replace cable

11. Disassembly / Assembly of rail | power FNC-HT cells and accessories

11.1. Disassembly of rail | power FNC-HT cells and accessories



DANGER!

Depending on installation conditions, there can be a risk of death or severe injuries when establishing access to or accessing the battery system, caused by the rolling stock or parts thereof, or the battery system.

Carry out the prescribed safety measures that apply to the required installation works on the rolling stock, see [2 Safety instructions on page 11](#).



DANGER!

- A battery always has a voltage at the terminals.
- Battery racks/trays are very heavy.
- A battery should not be grounded or shorted. Carry the battery racks/trays with an adequate number of persons or use suitable hoisting gear and transport equipment.



DANGER!

Use only fully insulated tools when working on batteries.



Note

- For rework, the battery system has to be accessed and dismantled from the vehicle. Depending on the installation situation (container on the roof, underfloor container, installation sideways in the train), the deinstallation must be done specifically.
- The deinstallation of the battery system out of the train must be carried out by the train manufacturer / train operator.
- After deinstallation, the battery system should be brought into a battery workshop for rework.

1. Disconnect all loads from the battery system.
2. Switch off the battery main switch.
3. Disconnect the electrical connection of the battery from the surrounding parts of the battery system (electrical parts in the e-box or similar) and the vehicle on all terminals. This has to be done depending on the specific installation situation.
4. Disconnect the mechanical connection between battery system and vehicle and dismantle the battery system. Use suitable lifting equipment (forklift, lifting gear) to lift the battery.
5. Bring the battery to stand on a safe ground in a battery workshop.
6. Dismount the water refilling system (plugs and tubes) if the battery is equipped with it, and clean it in warm water without adding any detergents.
7. Dismount the insulation profiles.

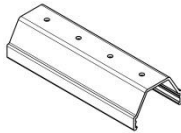

8. Loosen the terminal screws of the main terminals and lay the cables aside.

9. Remove the connectors between the cell rows first in the order given in the following example illustrations.

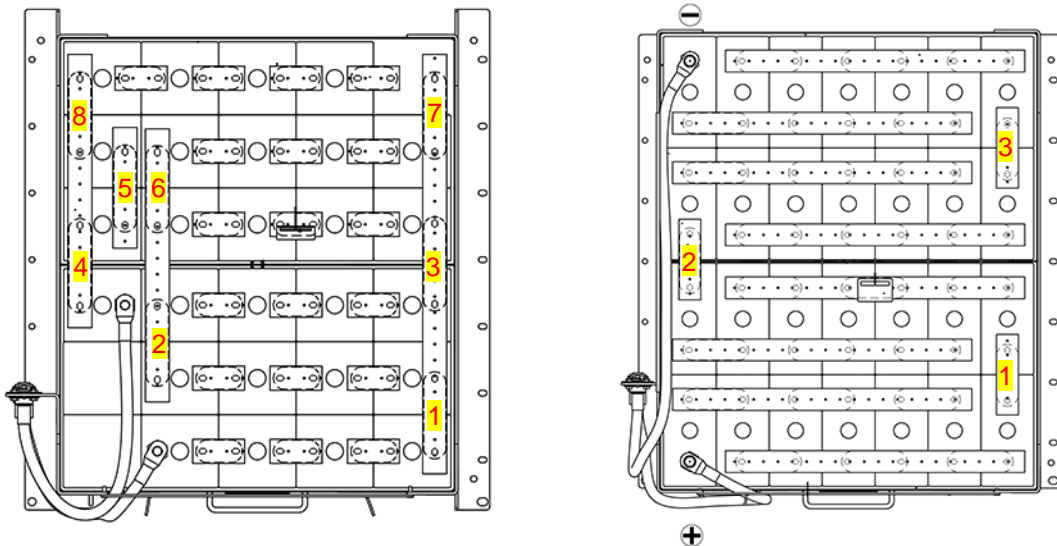

Note

The illustration above is an example. When working on the battery, the project-specific drawings must be used.

10. Then remove the connectors between the cells in the rows.



Note

For removing the connectors keep the following sequence:

- Loosen the terminal screws on the cell, but leave the last few turns in. Do not remove the terminal screws in this first step.
- Twist out the terminal screws the last few turns by hand and lay them aside for reuse.
- Lift out the connectors by hand and lay them aside for reuse.



DANGER!

- A battery cell always has a voltage at the terminals.
- Always remove the connectors very carefully in such a manner, that they do not shortcut the cell or adjacent cells.
- When removing the second screw of a connector, always hold the connector in the foreseen direction. This is to avoid shortcuts from rotation of the connector.

11. Lift out the cells one after the other.

**Note**

To lift the cell, use the Hoppecke cell lifter. (M8: HOPPECKE material number: 4141900002 / M10: HOPPECKE material number: 4141900003).

12. Lift out the spacer material if available (ribbed plates) and clean it in warm water without adding any detergents.

13. Prepare the tray or container for reuse by cleaning as follows on a suitable washing place:

In case of low contamination by electrolyte:

- Protect additional electrical components against liquid by using a plastic bag.
- Clean the tray under flowing water.
- Wash out any contamination with a clean, damp cloth without adding any detergents.
- Dry the tray with compressed air.

In case of strong contamination by electrolyte:

- Protect additional electrical components against liquid by using a plastic bag.
- Clean the tray by using diluted citric acid (5%).
- Clean the tray under flowing water.
- Wash out any contamination with a clean, damp cloth without adding any detergents.
- Dry the tray with compressed air.

11.2. Assembly of new rail | power FNC-HT cells and accessories



DANGER!

Depending on installation conditions, there can be a risk of death or severe injuries when establishing access to or accessing the battery system, caused by the rolling stock or parts thereof, or the battery system.

Carry out the prescribed safety measures that apply to the required installation works on the rolling stock, see [2 Safety instructions on page 11](#).



DANGER!

- A battery always has a voltage at the terminals.
- Battery racks/trays are very heavy.
- A battery should not be grounded or shorted. Carry the battery racks/trays with an adequate number of persons or use suitable hoisting gear and transport equipment.



Note

The cells are delivered sealed with yellow transport plugs. Keep the yellow transport plugs on the cells during the installation procedure until the vent plugs or water refilling plugs are installed.

1. Install the new cells according to the technical drawing. Use the ribbed plates if available to separate the cells from each other and from the tray, see following illustration. Information about the thickness of the ribbed plates can be taken from the drawings and parts lists.

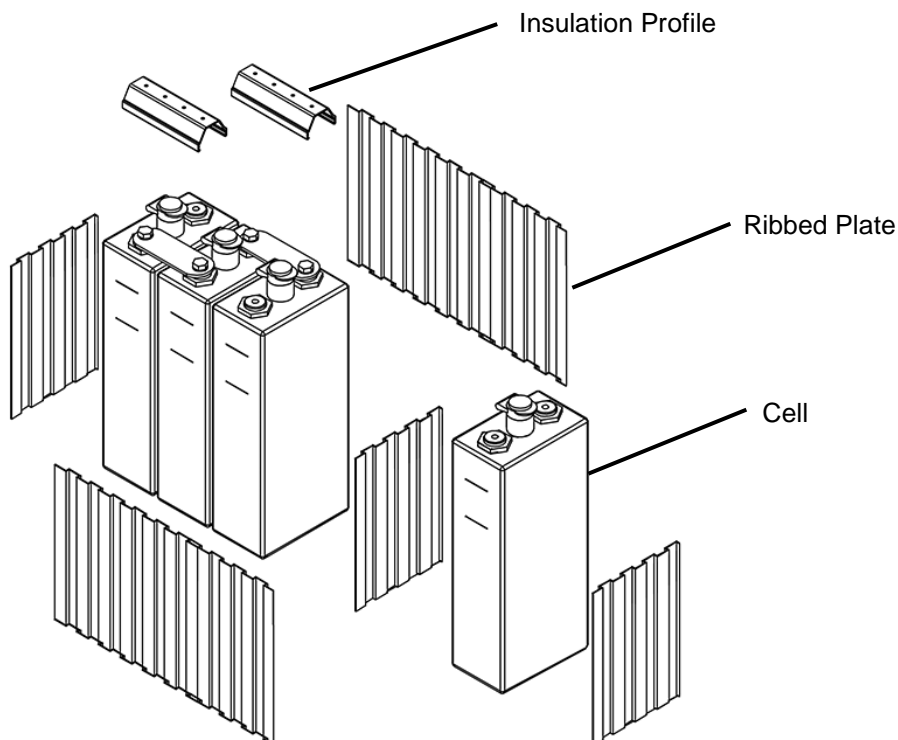



Note

The illustration above shows an example installation with ribbed plates.



Note

To lift the cell, use the Hoppecke cell lifter. (M8: HOPPECKE material number: 4141900002 / M10: HOPPECKE material number: 4141900003).

**Note**

To achieve a “press fit” installation of the cells into the tray keep the sequence of installation as described in following photos (example from a project):

Start at the main plus terminal and line up the cells on the outside wall of the tray according to the technical drawing. For crate installations of only one row, the middle cells should also be installed at the last position.

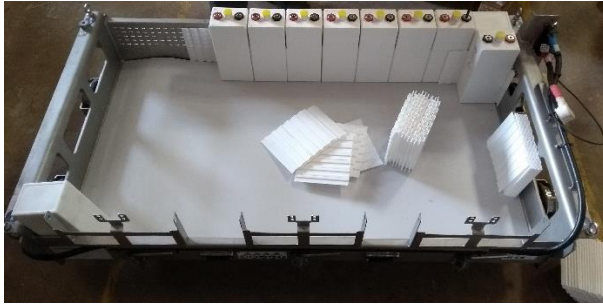

Proceed with the next row in direction to the middle of the tray and so on until all cells are placed:

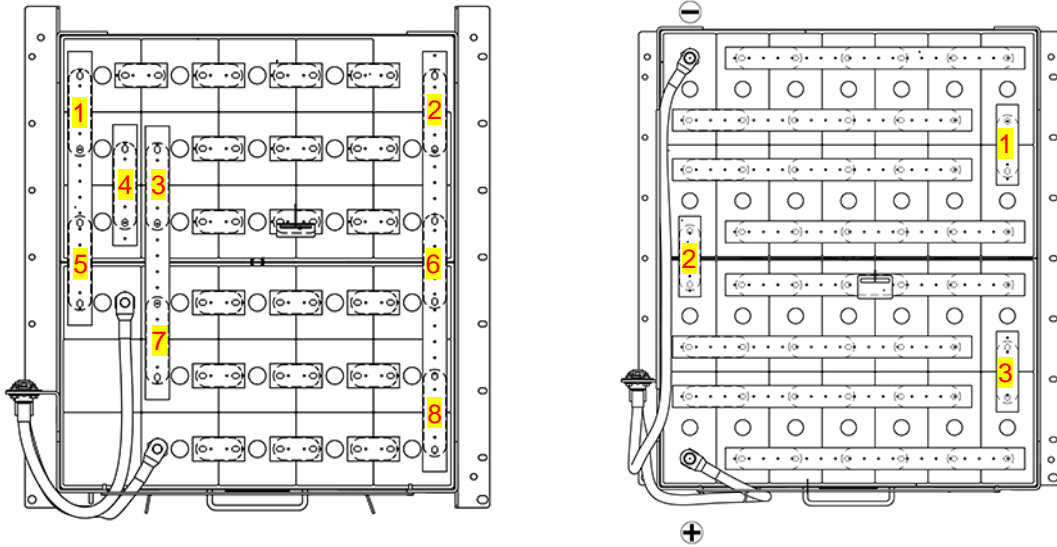

2. Install the cell connectors according to the technical drawing. Use new spring-washers. First install the connectors in the cell rows, then install the connectors between the cell rows in reverse order to the deinstallation, see following example illustrations:

**Note**

The illustration above is an example. When working on the battery, the project-specific drawings must be used.

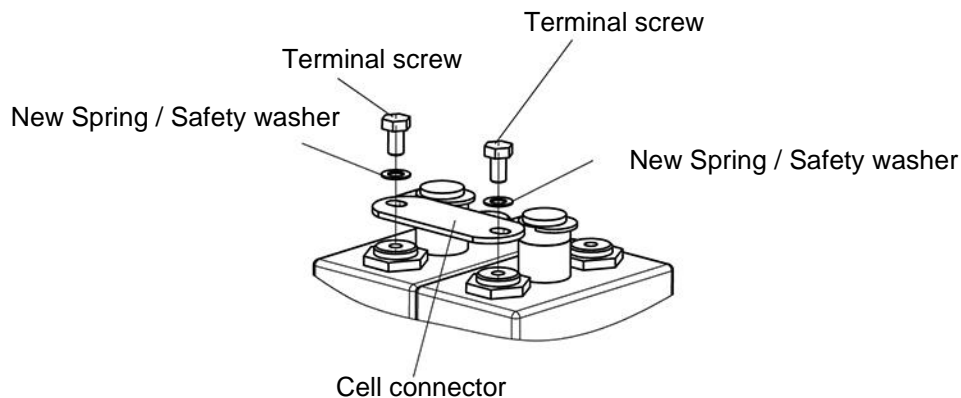
**Note**

For remounting the connectors keep the following sequence:

- Place the connector in the required position.
- Twist in the terminal screws the first turns by hand on both sides of the connector.
- Align the cells again finely.
- Tighten the terminal screws with a torque wrench.

**DANGER!**

- A battery cell always has a voltage at the terminals.
- Always install the connectors very carefully in such a manner, that they do not shortcut the cell or adjacent cells.
- When installing the first screw of a connector, always hold the connector in the foreseen direction. This is to avoid shortcuts from rotation of the connector.

**Note**

- M8 torque: 20 Nm \pm 1 Nm
- M10 torque: 25 Nm \pm 1 Nm
- Use new spring washers

3. Reinstall the insulation profiles.

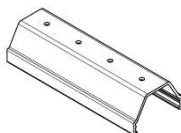

4. Dry the water refilling system if available (plugs and tubes) with compressed air.

5. Remount the water refilling system if available (plugs and tubes) or the vent plugs according to the technical drawing.

6. Reconnect the main cables by remounting the terminal screws of the main terminals.

7. Check the function of the battery according to the test specification in the separate document: PVE 10-20-General-00_Battery_Tray_rev<version-number>.pdf
8. Reinstall the battery into the vehicle and restore the mechanical connection. Use suitable lifting equipment (forklift, lifting gear) to lift the battery.
9. Reconnect the electrical connection of the battery to the surrounding parts of the battery system (electric parts in the e-box or similar) and the vehicle on all terminals. This has to be done depending on the specific installation situation.

**Note**

The reinstallation of the battery system to the train must be carried out by the train manufacturer / train operator.

10. Switch on the battery main switch.
11. Connect the loads to the battery system.

12. Disposal

**Note**

Observe the safety instructions, see [2 Safety instructions on page 11](#).

**Note**

Old batteries bearing this sign are recyclable economic goods and must be returned via the recycling process.

You can use the HOPPECKE recycling system. The old batteries are picked up and returned to the recycling system. Contact HOPPECKE Service for further information.

**Note**

Dispose of nickel cadmium batteries, which are not recycled, as special waste in compliance with all regulations.





Because of the cadmium and sodium hydroxide content, rail | power FNC-HT cells must never be disposed of with household waste or landfilled at the end of their service life.





Please observe the country-specific regulations and regulations for disposal separately

13. Appendix

13.1. Additional tools

The following lists additional tools for maintenance and service:

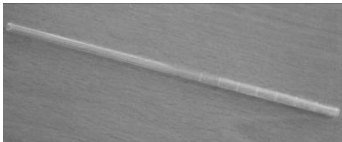
Tool	Description
	Voltmeter/multimeter (illustration shows an example)
	Current clamp DC (illustration shows an example)
	Contact thermometer (illustration shows an example)
	Insulation tester: Fluke 1507 HOPPECKE Mat. No.: 4141201237
	External charge/discharge unit (illustration shows an example)

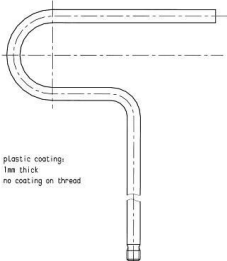
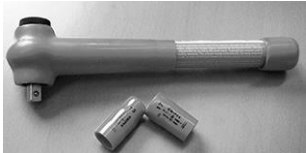
		<p>Waterfilling cart for central low pressure refilling system</p>
		<ul style="list-style-type: none"> • HOPPECKE Mat. No.: 4147000230 230 V • HOPPECKE Mat. No.: 4147000235 115 V
		<p>Waterfilling cart for single cells of format 1-5:</p>
		<ul style="list-style-type: none"> • HOPPECKE Mat. No.: 4147000210 230 V • HOPPECKE Mat. No.: 4147000215 115 V
		<p>Waterfilling cart for special cells with adjustable pistol</p>
		<ul style="list-style-type: none"> • HOPPECKE Mat. No.: 4147000225 115V • HOPPECKE Mat. No.: 4147000220 230V
	<p>Glass tube for measuring HOPPECKE Mat. No.: 4144140010</p>	
	<p>Gas venting tube HOPPECKE Mat. No.: 4143180110</p>	
 <p>plastic coating: has thick no coating on thread</p>	<p>Cell lifter Format 3, 4, 5 M10: HOPPECKE Mat. No.: 4141900003</p> <p>Format 1, 2 M8, HOPPECKE Mat. No.: 4141900002</p>	
	<p>Fully insulated torque wrench HOPPECKE Mat. No.: 4142500121</p>	

13.2. Commissioning protocol for HOPPECKE rail | power FNC-HT batteries

Vehicle: _____ Date: _____

Batterie No.: _____

Cell Type: _____

Number of cells: _____

Open circuit voltage (battery): _____ V

Charging voltage at start of charging: _____ V

Charging voltage at end of charging: _____ V

Charging time: from: _____ o'clock until: _____ o'clock

Measurement of the single cell voltages: see table on following sheet

Measurement of the electrolyte temperature (one cell):

Time after start of charging / h															
Temperature / °C															

Name: _____

Signature: _____

Single cell voltages

___ Commissioning charge

___ Reconditioning charge

Column 1: Open circuit voltage before charging, Start of measurement:

Date _____ Time _____

Column 2: Open circuit voltage after charging, Start of measurement:

Date _____ Time _____

Zellen Nr.	1 [V]	2 [V]	Zellen Nr.	1 [V]	2 [V]	Zellen Nr.	1 [V]	2 [V]
1			28			55		
2			29			56		
3			30			57		
4			31			58		
5			32			59		
6			33			60		
7			34			61		
8			35			62		
9			36			63		
10			37			64		
11			38			65		
12			39			66		
13			40			67		
14			41			68		
15			42			69		
16			43			70		
17			44			71		
18			45			72		
19			46			73		
20			47			74		
21			48			75		
22			49			76		
23			50			77		
24			51			78		
25			52			79		
26			53			80		
27			54			*1)		

*1) If the battery system consists of more than 80 cells, expand the table accordingly.

13.3. Maintenance protocol for HOPPECKE rail | power FNC-HT batteries



Note
In the case of a warranty claim, enter the activities and the measured values in the maintenance report

Number of battery system: _____

Number of train: _____

Date of commissioning: _____

13.3.1. Half-yearly maintenance interval

13.3.1.1. Maintenance - Visual inspection of the battery system

Interval (years)	Visual Inspection done (mark with cross)	Date	Inspector (Name)
0.5			
1			
1.5			
2			
2.5			
3			
3.5			
4			
4.5			
5			
5.5			
6			
6.5			
7			
7.5			
8			
8.5			
9			
9.5			
10			
10.5			
11			
11.5			
12			
12.5			
13			
13.5			
14			
14.5			

13.3.1.2. Maintenance - Check electrolyte level

Interval (years)	Check electrolyte level done (mark with cross)	Date	Inspector (Name)
0.5			
1			
1.5			
2			
2.5			
3			
3.5			
4			
4.5			
5			
5.5			
6			
6.5			
7			
7.5			
8			
8.5			
9			
9.5			
10			
10.5			
11			
11.5			
12			
12.5			
13			
13.5			
14			
14.5			

13.3.2. Yearly maintenance interval

13.3.2.1. Maintenance - Measurement of the charging voltage

Interval (years)	Measured value in V	Date	Inspector (Name)
1			
2			
3			
4			
5			
6			
7			
8			
9			
10			
11			
12			
13			
14			

13.3.2.2. Maintenance - Fill up electrolyte level

Interval (years)	Fill up electrolyte level done (mark with cross)	Date	Inspector (Name)
1			
2			
3			
4			
5			
6			
7			
8			
9			
10			
11			
12			
13			
14			

13.3.2.3. Maintenance - Cleaning

Interval (years)	Done (mark with cross)	Date	Inspector (Name)
1			
2			
3			
4			
5			
6			
7			
8			
9			
10			
11			
12			
13			
14			

13.3.2.4. Maintenance - Measurement of the insulation resistance

Interval (years)	Measured value in Ohm	Date	Inspector (Name)
1			
2			
3			
4			
5			
6			
7			
8			
9			
10			
11			
12			
13			
14			

13.3.3. Maintenance Interval every 5 years

13.3.3.1. Maintenance - Reconditioning

Intervall (years)	Done (mark with cross)	Date	Inspector (Name)
5			
10			

13.3.3.2. Maintenance - Measurement of voltage of single rail | power FNC-HT cells

Interval 5 years:

For the table headers applies the following:

- 1*: Open circuit voltage before charging
Note: If the open circuit voltage of a cell is < 1.2 V, contact HOPPECKE service.
- 2*: Open circuit voltage after charging
- 3*: Deviation of the single cell voltage to the average single cell voltage (sum of all cell voltages divided by the number of cells)
Note: If the individual cell voltages deviate more than ± 50 mV from the average of all cell voltages, contact HOPPECKE service.

Cell No.	1* [V]	2* [V]	3* [mV]	Cell No.	1* [V]	2* [V]	3* [mV]	Cell No.	1* [V]	2* [V]	3* [mV]
1				28				55			
2				29				56			
3				30				57			
4				31				58			
5				32				59			
6				33				60			
7				34				61			
8				35				62			
9				36				63			
10				37				64			
11				38				65			
12				39				66			
13				40				67			
14				41				68			
15				42				69			
16				43				70			
17				44				71			
18				45				72			
19				46				73			
20				47				74			
21				48				75			
22				49				76			
23				50				77			
24				51				78			
25				52				79			
26				53				80			
27				54				*1)			

*1) If the battery system consists of more than 80 cells, expand the table accordingly.

Date: _____

Inspector: _____

Interval 10 years:

For the table headers applies the following:

- 1*: Open circuit voltage before charging
Note: If the open circuit voltage of a cell is < 1.2 V, contact HOPPECKE service.
- 2*: Open circuit voltage after charging
- 3*: Deviation of the single cell voltage to the average single cell voltage (sum of all cell voltages divided by the number of cells)
Note: If the individual cell voltages deviate more than ± 50 mV from the average of all cell voltages, contact HOPPECKE service.

Cell No.	1* [V]	2* [V]	3* [mV]	Cell No.	1* [V]	2* [V]	3* [mV]	Cell No.	1* [V]	2* [V]	3* [mV]
1				28				55			
2				29				56			
3				30				57			
4				31				58			
5				32				59			
6				33				60			
7				34				61			
8				35				62			
9				36				63			
10				37				64			
11				38				65			
12				39				66			
13				40				67			
14				41				68			
15				42				69			
16				43				70			
17				44				71			
18				45				72			
19				46				73			
20				47				74			
21				48				75			
22				49				76			
23				50				77			
24				51				78			
25				52				79			
26				53				80			
27				54				*1)			

*1) If the battery system consists of more than 80 cells, expand the table accordingly.

Date: _____

Inspector: _____